

# Dx 1000 Industrial Slicer

# QUICK START

## UNPACKING THE MACHINE READ THE INSTRUCTION MANUAL COMPLETELY

LOCATE THE CARTON CONTAINING THE SLICING MACHINE  
UNPACK THE SLICER,

LOCATE THE PARTS PACKAGE CONTAINING:

- (4) ALUMINUM FEET
- (4) ½-13 X 1" THREADED ROD
- (4) ½-13 X ¾" HEX HEAD BOLTS

INSTALL THE (4) FEET ONTO THE UNDERSIDE OF THE SLICER.

- THREAD THE (4) ½-13 X 1" RODS INTO EACH ALUMINUM FOOT
- THREAD THE FEET INTO THE (4) ½-13 THREADED HOLES LOCATED ON THE UNDERSIDE AT THE FOUR CORNERS OF THE SLICER.
- RETAIN THE (4) ½-13 X ¾" HEX BOLTS FOR LATER USE. THESE BOLTS WILL ATTACH THE SLICER TO THE CART.

LOCATE THE CARTON CONTAINING THE CART AND CONVEYOR  
UNPACK THE CART, UNPACK THE CONVEYOR IF SO EQUIPPED.

- SET THE CART UPRIGHT.
- LOCATE THE DISCHARGE SIDE OF THE CART, THE SIDE WITH TWO LARGE 1 ½" HOLES CLOSEST TO AN EDGE.
- LOCATE THE DISCHARGE SIDE FOR THE SLICER, THE SIDE WITH THE KNIFE.
- LIFT THE SLICER ONTO THE CART.
- PLACE THE FOUR FEET OF THE SLICER INTO THE FOUR 1 ½" HOLES ON THE CART.
- ADJUST THE FEET UP OR DOWN AS NEEDED TO STABILIZE.
- USING THE FOUR ½-13 HEX BOLTS ATTACH THE SLICER TO THE CART.
- LOCATE THE RIGHT AND LEFT HAND GUARDS. INSTALL (SEE INSTRUCTIONS "Fig 1".)
- LOCATE AND INSTALL THE CLEAR POLYCARBONATE SAFETY GUARD. (SEE INSTRUCTIONS "Fig 2")

REMOVE THE KNIFE GUARD

- OPEN THE KNIFE GUARD DOOR. (ROTATE THE LEFT SIDE HAND KNOB COUNTERCLOCKWISE)
- CAREFULLY REMOVE THE RUBBER GUARD FROM THE KNIFE.
- CLOSE AND SECURE THE KNIFE GUARD DOOR.

# CAUTION:THE KNIFE IS VERY SHARP !

DETERMINE WHICH EQUIPMENT HAS BEEN INCLUDED WITH YOUR ORDER.  
FOLLOW THE INSTALLATION INSTRUCTIONS ASSOCIATED WITH EACH

POSSIBLE EQUIPMENT CONFIGURATION:

- 1) TRAY WITH ARMS (Fig 3)
  - 2). 20" CONVEYOR WITH ARMS (Fig 4)
  - 3) ROLLING CONVEYORS
  - 4) +SMART CONVEYOR
- INSTALL THE ARMS ONTO THE CART AS APPROPRIATE TRAY OR CONVEYOR.
  - (Fig 3) SLIDE THE STAINLESS TRAY BETWEEN THE ARMS ON THE CART ADJUST ARMS TO ACCEPT TRAY. TRAY SHOULD BE WITHIN AN INCH OF THE BOTTOM OF THE KNIFE GUARD DOOR..
  - (Fig 4) REST THE CONVEYOR ONTO THE ARMS PROVIDED.
  - INSERT THE TWO SECURING (2) PINS

## **DANGER: CONVEYOR INSTALLATION**

**THE TOP TWO SLOTS OF THE CART SHOULD NOT BE USED FOR ARM INSTALLATION ON CERTAIN MODELS AS THIS POSITION MAY ALLOW THE KNIFE TO CUT INTO THE BLUE CONVEYOR BELT. DROP THE CONVEYOR ARMS AND THE CONVEYOR TO INSURE THE KNIFE DOES NOT CUT INTO THE CONVEYOR. TEST FOR THIS CONDITION BY ROTATING THE KNIFE BY HAND USING THE HANDLES PROVIDED**

- IF EQUIPPED WITH A CONVEYOR BE SURE THE CONVEYOR IS SET AT A HEIGHT WHICH IS LOWER THAN THE ROTATING KNIFE.
- ROTATE THE KNIFE ONE TURN BY HAND (See Fig: H1) USING THE HANDLES PROVIDED TO INSURE THE KNIFE ROTATES FREELY AND DOES NOT CUT INTO THE TRAY OR THE CONVEYOR BELT.
- IF THE KNIFE CUTS INTO THE CONVEYOR BELT LOWER THE TWO SUPPORTING ARMS TO THE NEXT LOWER SET OF BOLT HOLES LOCATED ON THE CART.
- REMOVE ALL PACKING FROM MACHINE.
- SANITIZE THE MACHINE.

ELECTRICAL: SLICERS AND CONVEYORS ARE 120 VAC 60 HZ.  
PLUG INTO A STANDARD GROUNDED CIRCUIT

READ THE FULL MANUAL AND OPERATION INSTRUCTIONS  
WHICH ARE PROVIDED ONLINE AT:

[www.dxslicer.com](http://www.dxslicer.com)

## OPERATION

- Load Product into Machine
- Slice/ Layout:
- Slice Thickness Control:
- Start Push Button:
- Stop Push Button:
- Slice Count Control Dial:
- Space Delay Control Dial
- Emergency Stop:
- Open the Feed Door and load the product to be sliced.
- Close the feed door
- Choose either slice in bulk or slice into drafts.
- Rotate the slice thickness dial to the slice thickness desired.
- Press and hold the start button for one second. This will start the slicing cycle.
- Press the stop button to immediately stop the slicing machine.
- Press stop the button for one second to RESET the slicer to the home position.
- Turning this dial to the right will increase the number of slices per “draft”
- Turning this dial to the right will increase the space and time between the sliced “drafts” ’.
- Pressing the Red E-Stop button will cause all power to be shut off to the machine. Pull the E-stop to engage the power





**For the latest Quick Start Guides, Set up Instructions and System Manuals visit [www.dxslicer.com](http://www.dxslicer.com) Dx1000 page. Locate the “Manual” button.**

# Dx Industrial Slicers

Updated 01/2023

Operator's Manual

## Cleaning and Sanitizing Instructions:

	<p><b>Warning: Read and Understand All Warnings and Instructions.</b> Read and understand all warnings and instructions before starting procedures. Failure to follow warnings and instructions could result in serious injury or death.</p>
	<p><b>Cut and Amputation Hazard:</b> The blade is exposed during certain cleaning steps. The blade on this commercial slicer is extremely sharp. Severe injury can occur if care is not used when using or cleaning this product. Only trained personnel should operate equipment or perform maintenance. To reduce the risk of injury, use a cut resistant glove(s) when cleaning this equipment.</p>
	<p><b>Electrical Shock Hazard:</b> Keep water and other liquids from entering the inside of the equipment. Liquid inside the equipment could cause an electrical shock. Do not spray water or cleaning products. Liquid could contact the electrical components and cause a short circuit or an electrical shock. Do not use the equipment if the power cord is damaged or has been modified.</p>
	<p><b>Gaskets, Seals:</b> It is recommended that all gaskets and seals should be inspected daily during cleaning and sanitizing. In no case should the inspection of all gaskets and seals exceed six months. Thorough inspections should be made by the manufacturer representative at no longer than six months. The slicer should be removed from service until repaired by the manufacturer or its authorized service agent if any gasket or seal is found to be damaged, or missing.</p>

**NOTICE:** This machine shall be cleaned and sanitized each time the blade is sharpened.

**NOTICE:** This machine shall be cleaned and sanitized at intervals to comply with national, state and/or local health codes.

## **WARNING!**

Severe injury can occur if this equipment is not used properly. To reduce risk of injury or death:

1. Read and understand all instructions before using the equipment.
2. Keep out of reach of children.
3. Do not turn equipment on unless all guards are in place.
4. Do not feed food by hand: always use an automatic feed drive.
5. Equipment must be connected to a properly grounded electrical supply matching the nameplate rating.
6. Always engage the E stop switch or unplug equipment before cleaning.
7. Keep electrical panels away from water; avoid water jets during cleaning.
8. Equipment should only be used in a flat, level position.
9. Do not operate unattended.
10. Install or locate this appliance only in accordance with the provided installation instructions.
11. Do not operate this appliance if it has a damaged cord or a plug, if it is not working properly or if it has been damaged or dropped.
12. Do not immerse cord or plug in water. Keep cord away from the heated surface. Do not let the cord hang over the edge of the table or counter.
13. Do not use an extension cord with this equipment. Do not plug this equipment into a power strip or multi-outlet power cord.
14. Have equipment installed by qualified personnel in accordance with local codes and ordinances.
15. Do not spray controls or outside of equipment with liquids or cleaning agents.
16. Do not clean the equipment with steel wool.
17. Keep equipment and power cord away from open flames, electric burners or excessive heat.
18. SAVE THESE INSTRUCTIONS.

### **Check for Items which may have become loose.**

**Check all fasteners on the machine. Be sure any fasteners are tight and secure.  
Do not operate the machine without all parts securely fastened!**

## UNPACKING THE EQUIPMENT

### READ AND FOLLOW THE INSTRUCTION MANUAL COMPLETELY

#### Unpacking the equipment

- Working area must be dry, away from heating sources, and away from passageways.
- Unpack the slicer.
- Unpack the cart
- Unpack the conveyor, if so equipped.
- Remove all packing material and tape, as well as any protective plastic from the equipment.
- When no longer needed, dispose of all packaging and materials in an environmentally responsible manner.

#### Set up the equipment

- Set the cart upright..
- Locate the discharge side of the cart, the side with two large 1 ½” holes closest to an edge.
- NOTE: If a cart is provided, use only the four holes on the left side and center of the machine. The feet will then align to the holes in the cart.
- Locate the discharge side of the slicer, the side with the knife.
- Lift the slicer onto the cart.
- Place the four feet of the slicer into the four 1 ½” holes on the cart.
- Locate two additional parts, the front hand guard and the rear hand guard. Both parts are secured by rotating the front feet right and left up or down. Both parts are secured above the feet See page 5 for a more detailed description.
- Adjust the feet up or down as needed to stabilize the slicer. It is not necessary to perfectly level the slicer.
- Using the four ½-13 hex bolts provided, attach the slicer to the cart.
- Attach the clear polycarbonate guard.
- Slide the stainless steel tray between the arms of the cart. Adjust arms to accept the tray.  
NOTE: No tray is provided if a conveyor is included.

**NOTE: THE ACETAL CART TOP IS NOT NECESSARY FOR THE OPERATION OF THE SLICER. FOR SANITARY REASONS THE CART TOP MAY BE DISCARDED. THE SLICER MUST BE SECURED WITH THE FOUR HEX BOLTS DIRECTLY TO THE CART FRAME.**

## IMPORTANT!

ALWAYS WEAR STEEL MESH GLOVES DESIGNED TO REDUCE THE POSSIBILITY OF CUTS  
TO OPEN THE KNIFE GUARD.

CAREFULLY REMOVE THE RUBBER GUARD OVER THE KNIFE EDGE.  
THE KNIFE IS SHARP

## IMPORTANT!

ALWAYS USE THE TWO BLACK 4" HANDLES  
WHICH SCREW INTO THE KNIFE,  
WHENEVER HANDLING THE KNIFE.

# CAUTION:THE KNIFE IS VERY SHARP !

### The Knife

- Open the knife guard door
- Carefully remove the rubber knife guard and blue tape which is secured to the knife edge.
- Clean any glue residue left over from the plastic or tape.
- Keep the rubber knife guard for later use. It will be needed when removing the knife.
- **CHECK THAT THE KNIFE ROTATES FREELY.** Screw the two black 4" handles into the knife. Rotate the knife in a clockwise direction. One rotation only! Check that the knife does not hit the shear edge or any other obstruction.
- Close the knife guard door
- Close and lock the knife door by threading the hand knob fully into the knife frame.
- **IF EQUIPPED WITH A CONVEYOR BE SURE THE CONVEYOR IS SET AT A HEIGHT WHICH IS LOWER THAN THE ROTATING KNIFE.**

### Safety Cover

- A clear polycarbonate safety cover is provided.
- Secure the cover to the knife guard door with hardware provided
- Attach the two stainless hand guards

**DO NOT OPERATE THE MACHINE WITHOUT THE SAFETY COVER PERMANENTLY SECURED.**  
**NEVER REMOVE OR RAISE THE COVER**

### Electrical

- 120VAC 60HZ 20 AMP SERVICE IS REQUIRED.
- Plug all equipment into a properly grounded electrical supply matching the nameplate rating. Damage to the equipment can occur if incorrect power is supplied to equipment.

### Sanitize the Machine

- Before using this equipment it must be cleaned thoroughly. Clean all surfaces before use. Failure to clean surfaces before using the equipment could cause food contamination

## Secure the Slicer to the Cart \*(if so equipped)

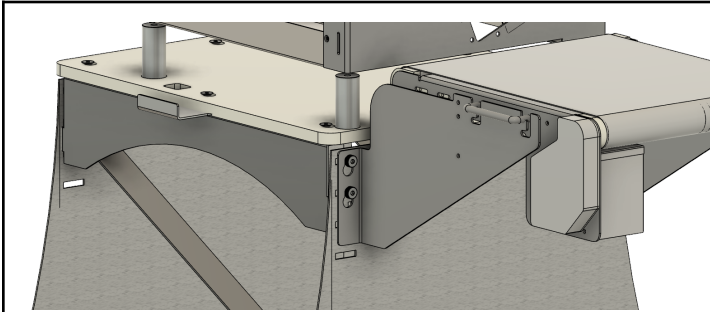

- 1) Locate the two 1 ½" diameter holes closest to the cart top edge. This is the front side of the cart.
  - 2) Locate the front, discharge side of the slicer
  - 3) Lift the slicer onto the cart taking care to place the two "front" feet into the front holes of the cart.
  - 4) Adjust for level.
  - 5) Note: The four feet are adjustable for height. If a rocking movement is present, adjust the feet on the slicer. This is done by rotating the aluminum feet to the left or right.
  - 6) Start at the far back- left foot. Normally this foot would need to be adjusted ½" down in height.
- IF SO EQUIPPED:
- 7) Once the Slicer is stable on the cart, locate the Four ½-13 hex bolts and lock washers (provided). From the underside of the White Acetal top, insert the bolts into the threaded feet.
  - 8) Tighten the bolts.

## Secure Cart Support Brackets.

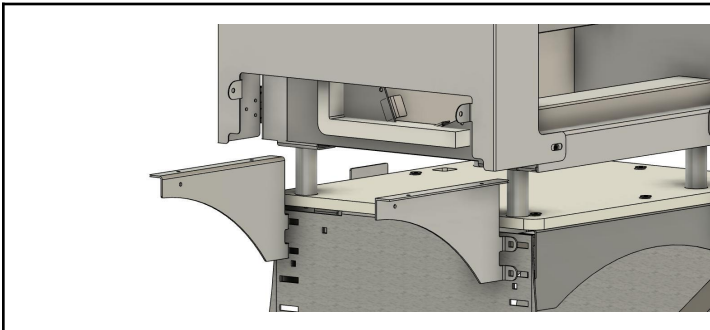

- 9) Locate the pair of cart arms for either the pan or the conveyor depending on the model.
- 10) Secure the cart arms using the carriage bolts provided on the front of the cart.
- 11) Adjust the height and width of the arms depending on which receiving trays you are using.
- 12) Tighten the bolts.

## Attach the Clear Polycarbonate Takeaway Guard

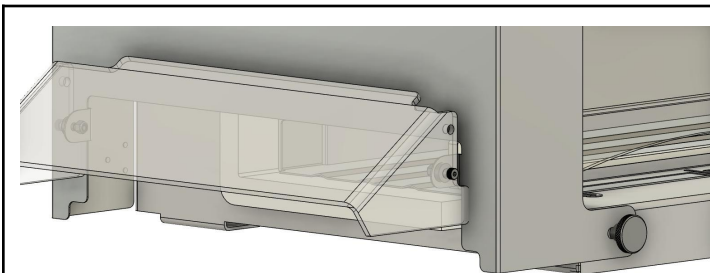

- 1) Locate the clear polycarbonate guard.
- 2) Position the guard on the front knife guard.
- 3) Attach using the shoulder screws, spacers and locking hex nuts provided.
- 4) The guard can be raised or lowered to accommodate the height of the fixed tray provided, a conveyor or a tub (not provided).
- 5) It is necessary that the polycarbonate guard is positioned to prevent anyone from putting their hands or fingers into the knife slicing area.
- 6) THE USE OF THE GUARD IS REQUIRED.

**NOTE: ALL SAFETY GUARDS MUST BE SECURELY AND PERMANENTLY ATTACHED TO THE SLICER. NEVER OPERATE THE MACHINE WITHOUT ALL SAFETY GUARDS.**



NOTE: If so equipped, Attach the blue conveyor cable to the slicer. Attached to the 12mm threaded fitting located in the mechanical housing on the right side of the slicer.

Always use the two pull pins located on either of the 20" conveyor to secure the conveyor to the support arms.

Do not operate the unit without the pull pins securely attached.

**WARNING: ROTATE THE KNIFE BY HAND AFTER THE CONVEYOR INSTALLATION.  
DO NOT ALLOW THE KNIFE TO CUT INTO THE CONVEYOR BELTING.  
DROP THE CONVEYOR 1" OR MORE TO ALLOW FOR CLEARANCE**

## Connecting the Slicer

This equipment is intended to be used with a 120VAC 60 Hz 20 Amp dedicated circuit.

A three prong cord and plug is included.

Do not permanently wire this machine to any electrical supply.

The machine is designed to be unplugged daily, typically during cleaning.

### Installation:

Install this Slicer in a well ventilated location that provides easy access for inspection.

The location must also satisfy the following conditions:

Indoors

Operating Ambient Temperature

AC Line Voltage 120 VAC +/- 10% 50/60Hz

0 to +40 C (+32 to +104 F) Non- Freezing

Area that is free from an explosive atmosphere or toxic gas or liquid

Area not exposed to direct sun

Area free from excessive salt

Area not subject to excessive shock

Area not subject to other machinery (such as forklift) which might cause the machine to be struck, or become unbalanced or "tip"

Area free of electromagnetic noise such as other power machinery

Area free from radioactive fields, magnetic fields or vacuum

---

## Function and Purpose

This equipment is intended to be used to slice edible food products in commercial foodservice operations only.

It is not recommended to be used with bone-in meat. It is not intended for household or laboratory use.

This equipment is designed to run on an intermittent basis. Do not run continuously.

# Familiarize yourself with all parts of the Slicer

## Features and Controls

	<p>Front of Slicer:</p> <ul style="list-style-type: none"> <li>Knife Guard Door</li> <li>Knife Guard Hand Knob</li> <li>Polycarbonate Takeaway Guard</li> <li>Control Panel</li> <li>Polycarbonate Feed Door</li> <li>Mechanical Guard Door</li> <li>Mechanical Guard Hand Knob</li> <li>Rear Access Panel</li> </ul>
-----------------------------------------------------------------------------------	-----------------------------------------------------------------------------------------------------------------------------------------------------------------------------------------------------------------------------------------------------------------------------------------------------------------------

## Mechanical Chamber (Back of Machine)

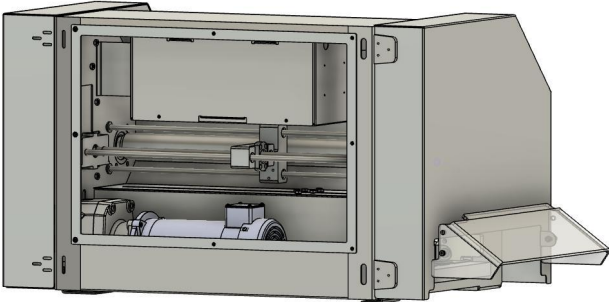
	<p>Mechanical Chamber Rear of Slicer</p> <ul style="list-style-type: none"> <li>Electrical Panel</li> <li>Ball Screw Drive</li> <li>Linear Shafts (4)</li> <li>Gear Reducer</li> <li>1HP 90 Vdc Main Drive Motor</li> </ul>
--------------------------------------------------------------------------------------	---------------------------------------------------------------------------------------------------------------------------------------------------------------------------------------------------------------------------------

Lubricate the Ball Screw and Linear Shafts regularly and in accordance with the Maintenance instructions

## Control Panel and Operation

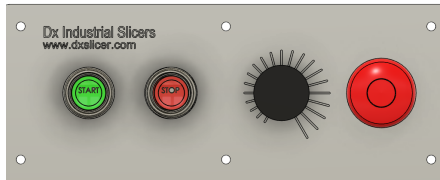

Start Button  
 Slice Thickness Control  
 Stop Button  
 Emergency Stop

### Start Push Button:

Press and hold the start button for one second. This will start the slicing cycle. The main motor will start. A few seconds later the feed motor will start and advance the feed at the desired (slice thickness) rate of speed. When the slicing arm has advanced to the full extent the main motor will stop and the feed arm will return to the "Home" position. The slicer will then shut off, ready for the next product.

### Stop Push Button:

Press the stop button to immediately stop the machine.

Press and hold this button to RESET the machine to the home position. This will also clear any faults.

NOTE: The momentary pressing of the STOP button just after the product has started slicing will allow the operator to check for correct slice thickness.

### Slice Thickness Control:

Rotating this dial to the right creates thicker slices. Rotating the dial to the left creates thinner slices.

NOTE: Slice thickness must be chosen before the "Start" push button has been pressed. Once Start is pressed the thickness is locked in.

### Emergency Stop:

Pressing the Red E-Stop button will cause all power outside of the electrical enclosure to the machine to be shut off.

Pull on the E-Stop button to re-energize and resume all for normal operation.

**NOTE: Once "start" has been pressed the slicing operation is automatic. Do Not open the feed door until the feed arm has returned to the "home" position and the slicer is shut off.**

## Slice Thickness on a Dedicated Slicing Machine

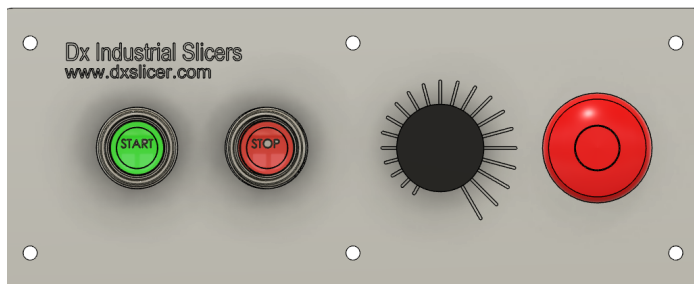

### The Slice Thickness Selection Dial

The Slice Thickness selector switch is a binary coded switch which, when rotated, references a specific address in the machine's controller. Slice thickness is controlled.

Overall range of slice thickness on any specific machine has been pre programmed. These are dedicated food processing machines designed to do one task well- i.e Bacon Slicer (appx  $\frac{1}{8}$ " ), Jerky Slicer (appx 4.5mm) Philly Steak Slicer (appx 1mm thick).Each is programmed to a specific customer's needs. Slice range can be changed. Contact customer support for details.

### NOTE: THERE IS NO "MAGIC SLICING BUTTON"

While these machines can slice a wide variety of cooked and raw products through a wide range of temperatures, these machines are NOT designed to slice all products, product thicknesses and temperature ranges at the same time

**.JUST AS THERE ARE DIFFERENT CARS AND TRUCKS IN THE WORLD WHICH ALL DO DIFFERENT JOBS, THERE ARE DIFFERENT SLICERS AND CONVEYORS EACH OF WHICH ARE DESIGNED FOR SPECIFIC SLICING NEEDS.**

It is recommended that you consult with your Dx Industrial engineering representative when selecting your slicer to ensure you choose the machine which will best suit your needs. Adjustments to the slice thickness range is possible but should be performed in consultation with qualified Dx Industrial personnel. Contact Dx Industrial technical support at (309) 590-0300 option 1 for further information.

Different Machines for Different Jobs.

We offer different machines for different jobs.  
Know what product you wish to slice.  
Each slicer has specific benefits.  
Each slicer has specific drawbacks.

### Dx Industrial Slicers

**Dx 1000.** A Deli Slicer. Designed to slice smaller products. Generally the feed openings are designed to accommodate 4" x 4" x 18" long products.  
Raw (frozen), cured or cooked.

**Dx 2000.** Dedicated Bacon Slicer including beef or pork flat products. It is an extended length slicer. Bacon must be frozen for proper lay down. The feed opening is designed to accommodate 4" high x 12" wide x 26" long products.  
Raw (frozen), cured or cooked.

**Dx 3000 Standard** Designed to slice larger deli products, raw (frozen), cooked or cured products. The feed opening is designed to accommodate 4 ½" high x 12" wide x 18" long products.  
Raw (frozen), cured or cooked.

**Dx 3000 Tall.** Designed to slice larger deli products, raw (frozen), cooked or cured products including taller hams and turkey breast. The feed opening is designed to accommodate 6" high x 8" wide x 18" long products.  
Raw (frozen), cured or cooked.

A Product Slicing Guide is available in Appendix A attached to this document  
or at:

**<https://www.dxslicer.com/slice-guide>**

### Mechanical Chamber: Belts and Drives

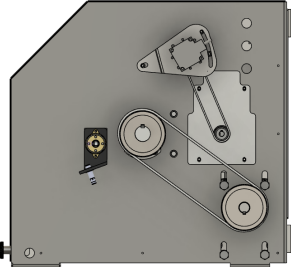
	<p><u>Belts and Drives</u>  Main Shaft Timing Pulley  Motor Shaft Timing Pulley  (4) Main Motor Tensioning Bolts (loosen bolts to change the timing belt)  Timing Belt 750T  Feed Drive Motor  Feed Drive Motor Timing Pulley  Feed Motor Tensioner (loosen bolts to change the timing belts)  Ball Screw Timing Pulley  Timing Belt 504T  Feed Door Proximity Sensor</p>
-----------------------------------------------------------------------------------	-------------------------------------------------------------------------------------------------------------------------------------------------------------------------------------------------------------------------------------------------------------------------------------------------------------------------------------------------------------------------------------------------------------------

### Knife Slicing Chamber

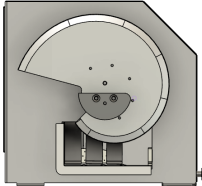
	<p>Knife Slicing Chamber  Involute Knife  Knife Counterweight  (1) Hex Screw 1"  (2) Flat Screws 2 3/4"  Shear Edge  Triple Hold Down</p>
-------------------------------------------------------------------------------------	-------------------------------------------------------------------------------------------------------------------------------------------------------------------

### Shear Edge

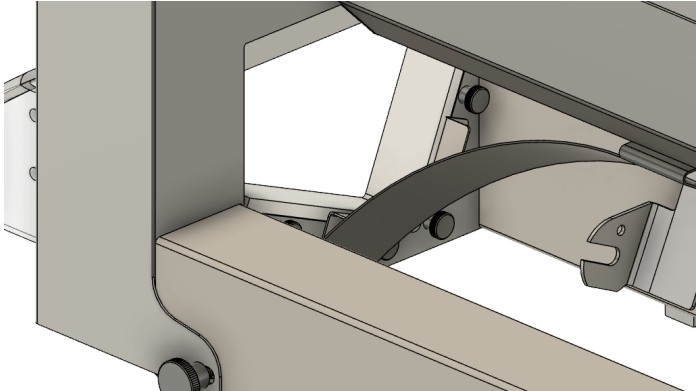
	<p>Shear Edge (Feed bed removed)  Shear Edge showing (4) hand knobs.  Be sure the knurled knobs are tight  Be certain the shear edge is properly installed  Rotate by hand (using handles provided) the knife to ensure the knife rotates freely.</p>
-------------------------------------------------------------------------------------	-----------------------------------------------------------------------------------------------------------------------------------------------------------------------------------------------------------------------------------------------------------------------

### Slicing Chamber

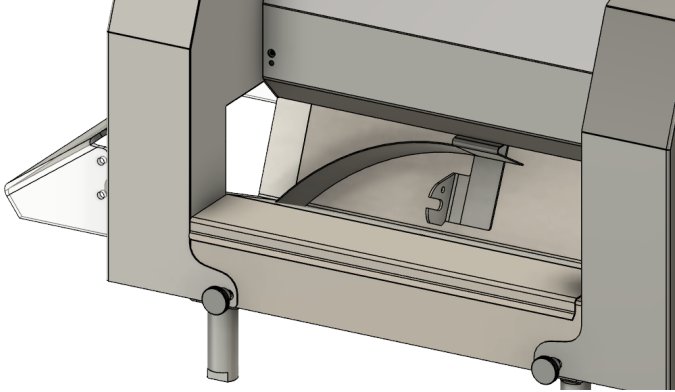
	<p>Feed Drive Area (Feed door raised)</p> <p>Dual Hold Dows Gripper Gripper Feed Arm Side Guide</p> <p>NOTE: The gripper arm is shown in the home position, all the way to the right.</p> <p>NOTE: This is a critical food contact area. Clean thoroughly daily.</p>
-----------------------------------------------------------------------------------	----------------------------------------------------------------------------------------------------------------------------------------------------------------------------------------------------------------------------------------------------------------------------------

### Safety: Proximity Sensors

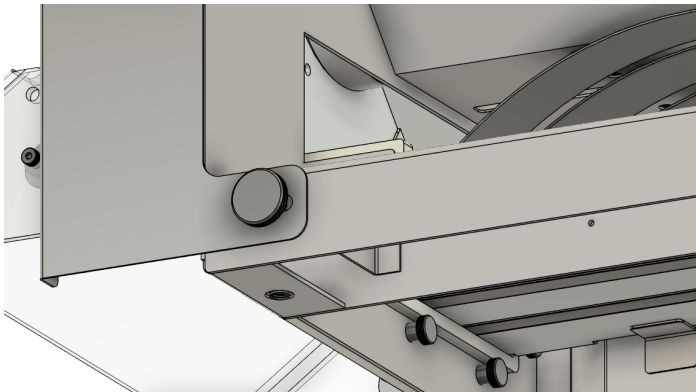
	<p>There are (2) two safety proximity sensors located on each slicer.</p> <p>The <b>Knife Guard Door sensor</b> is located next to the front guard hand knob. The sensor LED can be seen lit by looking under the machine at the hand knob. The bottom is open for inspection.</p>
------------------------------------------------------------------------------------	------------------------------------------------------------------------------------------------------------------------------------------------------------------------------------------------------------------------------------------------------------------------------------

	<p>The <b>Feed Door Guard Sensor</b> is located in the mechanical compartment to the left side of the machine. Turn the mechanical guard hand knob, open the guard and the lit proximity safety LED can be observed.</p>
-------------------------------------------------------------------------------------	--------------------------------------------------------------------------------------------------------------------------------------------------------------------------------------------------------------------------



Fig 15. Safety Pin / Gripper

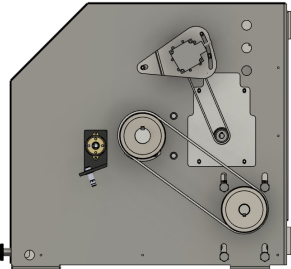
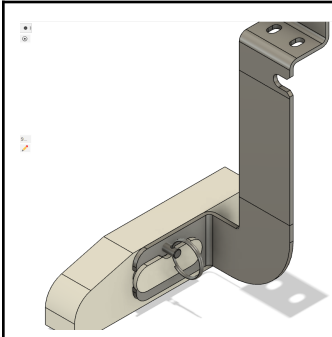

**Pin the Gripper**

Use the safety pull pin / lanyard provided to secure the gripper to the gripper feed arm.

This ensures the gripper does not come loose and pass through the knife.

Check this pin is secure each time the product is loaded.

## Safety features which may affect daily operation

Safety Feature: Opening of the Feed Door.

The opening of the feed door will stop the operation of the machine. It will turn off the power to the controller and power to the two motors. The reset of this feature requires an operator acknowledgement and subsequent action:

- 1) Close the feed door.
- 2) Wait 1-2 seconds for the controller to become active, reset faults and generally "wake up".
- 3) Once the feed door has been opened it is required that the operator presses either "start" to continue the slicing operation or to press and hold "stop" to return the feed arm to its home position.

Safety Feature: Overloading the machine.

Placing too much product into the feed chamber.

---

**Never Double Stack the Bacon Bellies.  
Never put product into the feed chamber which is too large,  
too heavy, too wide or too frozen for the machine.  
This can cause damage to the slicer.**

---

The Slicer is programmed to sense an overload condition:

If:	Then:
1) The product present is too tall	1) The machine will stop
2) The product present is too heavy	2) The feed arm will "stall"
3) The product present is too dense	3) The feed arm will not advance to its full extent or be able to return to home
4) The product is too cold	4) The feed belt may slip causing the loss of "home" position
5) An obstruction exists	

If the feed belt has slipped then a manual reset of the feed drive mechanism is required.

The Manual Reset Operation:

- 1) Stop the machine.
- 2) Press the Estop to de-energize the machine.
- 3) Open the right side maintenance door by rotating the hand knob.
- 4) Locate the feed belt drive motor. It is the small black motor center upper of the maintenance compartment.
- 5) Locate the two ¼-20 hex bolts and the third ⅜-16 hex bolt. Loosen all three slightly.
- 6) Remove the feed drive belt only. The smaller and upper most of the two belts in the chamber,
- 7) Reactivate the EStop,
- 8) Press and hold the "stop" pushbutton on the control panel.
- 9) Wait for the feed drive motor to stop running. It is now in the home position.
- 10) Locate the timing pulley located on the feed drive ball screw.
- 11) Rotate the timing pulley in a counter clockwise direction fully until it can be rotated no more.
- 12) Check the Feed Arm in the slicing chamber. Observe to see that the arm is in the original home position. The arm should be all the way to the right.
- 13) Re-attach the feed drive belt.
- 14) Move the Tensioning Arm to provide tension to the feed belt.
- 15) Tighten the three tensioning bolts while maintaining tension on the feed belt.
- 16) Close the Mechanical housing door. Tighten the hand knob.

The machine has now been set to its home position.

Proceed with normal slicing.

## Cleaning

To maintain the appearance and increase the service life, clean your equipment daily.

### Disassemble the Slicer

1. Make sure the slicer is in the “home” position and is powered “off”. **UNPLUG THE MACHINE.**  
If the gripper is not in the home position press and hold the “stop” button until the slicer feed arm returns to “home” position and shuts off. If the machine is not powered off, press the Emergency Stop push button.  
Unplug the machine from the electrical outlet.
2. Remove all of the removable parts. Depending on your slicer the parts may include:
  - Feed Bed Tray
  - Shear Edge
  - Gripper
  - Knife
  - Front Cover
  - Hold Down
  - Side Guide
3. Wash the removable parts in a clean basin filled with a solution of clean warm water and mild detergent.
4. Rinse the parts with clean warm water.
5. Use a soft cloth, clean warm water and a mild detergent to clean the non-removable parts of the slicer:
  - The front and back sides of the knife guard door. From the backside of the knife guard, carefully wipe the inside and outside edge of the guard.
  - Feed tray area including the right and left sides, the rear of the feed chamber. Take care to wash the hold down, the upper portion of the feed chamber.
  - Body of the slicer.
  - Underneath the slicer.
  - The top sides and rear of the slicer body.
6. Rinse all areas which have been cleaned including the feed chamber and all the non-removable parts of the slicer with clean warm water.

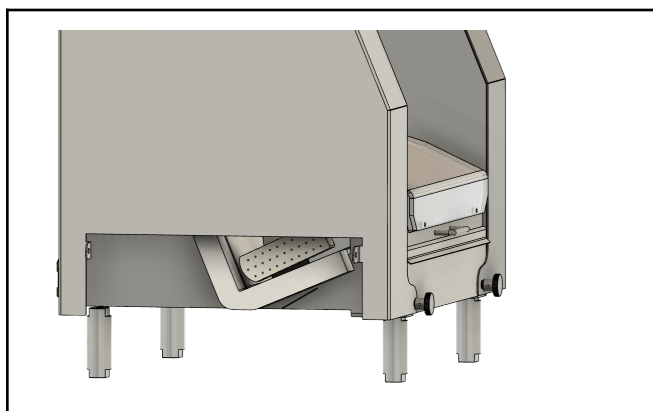

**NOTICE:** Do not clean the equipment with abrasive materials or scratching cleansers. These can damage the finish. Clean the slicer with only water, a mild detergent and sanitizing solution.

**NOTICE:** Hand wash only.

- „ Inspect that the slicer is working properly and in good condition before each use or at least every 90 days.
- „ If the slicer is not functioning properly do not use it. Have the equipment serviced by an authorized Dx Industrial Slicer service agency.
- „ All Neoprene seals are to be inspected by qualified personnel a minimum of every 90 days. If the seal is faulty, do not use it. Have the equipment serviced by an authorized Dx Industrial service agency.

**Note:**

- „ The sanitizer concentration shall comply with Section 4-501.114, Manual and Mechanical Warewashing Equipment, Chemical Sanitization – Temperature, pH, Concentration, and Hardness of the FDA Food Code.
- „ If a chemical sanitizer other than chlorine, iodine or quaternary ammonium is used, it shall be applied in accordance with the EPA registered label use instructions.
- „ This slicer shall be cleaned and sanitized at intervals to comply with national, state and/or local health codes.
- „ This slicer shall be cleaned and sanitized each time the knife is used.

## Sanitize the Slicer

**NOTICE: The sanitizer concentration shall comply with Section 4-501.114, Manual and Mechanical Warewashing Equipment, Chemical Sanitization – Temperature, pH, Concentration, and Hardness of the FDA Food Code. If a chemical sanitizer other than chlorine, iodine or quaternary ammonium is used, it shall be applied in accordance with the EPA registered label use instruction.**

1. Wash your hands.
2. Sanitize all the removable parts and the slicer.
3. Soak the removable parts in a clean basin, in a solution of clean warm water and correctly diluted sanitizing solution.
4. Remove the parts from the basin and allow them to air dry.
5. Moisten a soft clean cloth with correctly diluted sanitizing solution.
5. Wipe the slicer with correctly diluted sanitizing solution.
5. Use the cloth to sanitize the non-removable parts and body of the slicer.
6. Do not rinse or wipe off the sanitizer.

## Assemble and Lubricate the Slicer

- Reinstall the removed slicer parts.
- Lubricate the Feed Drive Ball Screw and the Interior Parallel Shafts located within the rear mechanical chamber using the oil supplied with the slicer or an equivalent food-grade lubricating oil. The lubrication procedure should be performed once per month.
- See Lubrication Section for additional information.

## Inspect the Slicer

Inspect the slicer for correct assembly and verify the slicer is in good working condition. • Do not use the slicer if it is not in good working condition. Contact an authorized Dx Industrial service department to service the slicer.

Inspect all items which had been removed during cleaning.

Take care to be certain all screws and fasteners are tight and secure including:

- Hold Down(s) and hold down screws.
- Ensure the gripper pins are attached and the Gripper is properly seated in the feed drive arm.
- Shear edge is tightly fastened and does not interfere with the rotation of the knife.
- Tray is properly installed and will not interfere with the movement of the feed arm.
- Knife guard door hand knob is fully tightened.
- Knife and Mechanical guard are closed and secure.

**NOTE: NEVER OPERATE THE SLICER WITHOUT A GRIPPER SECURELY ATTACHED**

## Removing the Knife:

### **WARNING: ATTACH THE RUBBER KNIFE EDGE GUARD WHENEVER HANDLING OR REMOVING KNIFE. SECURE WITH TAPE.**

To remove the knife during the cleaning and sanitizing process:

- Open the knife guard door.
- Attach the two knife safety handles provided into the threaded holes on the knife.
- Take care to ensure the safety handles are securely attached.
- Position the rubber knife guard over the knife with the knife still attached to the slicing machine.
- Secure the rubber guard with blue adhesive tape or equal.
- Take care to ensure the rubber guard edge fully covers the sharp edge of the knife.
- Take care to ensure the rubber guard is being held with the adhesive tape.
- Only when the rubber guard is securely attached to the knife is the knife safe to remove, wash and sanitize.
- Hold the knife safety handles securely when removing the knife from the machine.
- Use a  $\frac{3}{8}$ " hex Allen wrench to remove the two flat head screws holding the counterweight
- Carefully hold the counterweight. It will rotate freely when both screws have been removed.
- Remove the counterweight.
- Hold onto one of the Safety handles.
- Take care to ensure control over the knife is maintained during the removal of the knife.
- The knife can rotate and cause severe injury.
- Loosen and remove the  $\frac{1}{2}$ -13 hex screw.
- Hold onto the two knife safety handles .
- Remove the knife to a safe flat area.
- Wash in a basin. Sanitize.

Reinstalling the knife after the sanitizing process:

- With handles attached to the knife firmly lift the knife and center on the  $\frac{3}{8}$ " centering pin located on the balancing head.
- Rotate the knife until the three mounting holes are aligned.
- Install the  $\frac{1}{2}$ -13 Hex head screw.
- Tighten securely.
- Attach the 2" counterweight (along with the .120 counterweight if supplied).
- Attach the two  $\frac{1}{2}$ -13 x 3" Flat screws using the  $\frac{3}{8}$ " Allen wrench.
- Tighten securely.
- With handles attached rotate the knife in a clockwise direction to ensure the knife can rotate freely.

## Maintenance of Seals, Gaskets and Bearings:

**Inspect the machine!** If there are any areas on your slicer where water seems to accumulate, dry the areas with a non-linting towel, and lubricate them to prevent rust or corrosion.

### **Areas for inspection after each cleaning:**

- In regard to gaskets in the food splash zone. The design of the Dx slicer has removed all fixed gaskets. Gaskets have been replaced with parts that are removable without tools. These parts are required to be cleaned and sanitized after each use. See Cleaning and Sanitizing section.
- Non-food splash zone gaskets should be inspected daily and as the machine is cleaned. If any seal or gasket is observed to be failing the item should be replaced immediately.
- If the water appears to be expressing from joints or sealed areas you may need to replace gaskets or other components if they're collecting water.
- Gaskets are located under the front cover of the machine along the right and left edge (see Fig 1, J) where the stainless cover meets the vertical side support frame. If water seems to accumulate along the side support frame of the feed bed, the gasket may have to be replaced. Call our service department.
- Inspect the front control switches. If water appears from under the panel or control switches and or "boots," the seals or boots may need to be changed. Call our service department.
- The rear mechanical housing cover. If water seems to appear from under the seal, inspect and replace the seal gasket.
- Feed tray area is a food contact area. If water or oil appear in any of these areas, discontinue using the machine. Call our service department.
- If water which is not associated with cleaning or oil appears in the knife slicing chamber or a food contact area, **discontinue using the machine**. Call our service department.
- If oil appears at the right of the machine under the mechanical guard chamber, Call our service department.

**WARNING: All bearings on this machine are permanently sealed. At no time should oil appear at the front or rear bearing housing areas. If oil appears, call our service department.**

## Hone the Knife

**Honing** is basically maintaining an already sharp edge. When you **hone**, you polish the rough surface of the **knife's** edge which reduces friction and allows the **knife** to cut into material better. So, **sharpening** is making your blades sharper and **honoring** is keeping them that way.

**Sharpening** of the knife can only be done at a sharpening facility which is equipped to handle involute knives. The knife itself is ¼" thick hardened plate stainless steel. You cannot sharpen this knife in your facility. Contact us or an experienced knife sharpening company when your knife becomes dull.

- Hone the knife daily after each use or any time that cutting becomes difficult and/or produces a large amount of waste.
- The slicer should be considered and treated as a knife: if it is not adequately honed and sharpened, the slicing results will be poor and the machine will be overloaded.

**WARNING:** Operators must wear the cut resistant gloves (not provided).

To hone the slicer knife:

- Press and hold the stop switch for three seconds. Be sure the gripper has returned to the home position.
- Press the E stop Switch.
- Unplug the machine.
- Open the Knife guard door.
- Clean the knife following the Cleaning and Sanitizing Section of this manual.
- Use a 200 grit or finer hone stone.
- The back of the knife is flat. Take care to place the hone parallel to the back surface and draw the stone toward you.
- The front bevel of the knife is 15 degrees. Draw the stone toward you maintaining the 15 degree angle or as close as possible.
- Repeat this procedure as many times as necessary to produce a polished edge.
- The use of a rawhide strip is encouraged after the honing process. This will remove any residue left by the honing process.
- Clean the equipment to remove any residue. Follow the Cleaning and Sanitizing section of this manual



1. Press the E-STOP button located on the control panel of the slicer or unplug the machine..
2. Wear cut resistant gloves
3. Locate the 4" black handles provided with your slicer.
4. Firmly screw one handle into any available  $\frac{3}{8}$ -16 threaded hole. This will allow the operator to safely rotate the knife during the honing operation.
5. Locate the fine side of the flat hone stone provided with the slicer.



Fig: H1

NOTE: The back of the knife is flat. Its has a zero degree of angle



Fig: H2

NOTE: The front of the knife has a 15 degree angle of bevel.

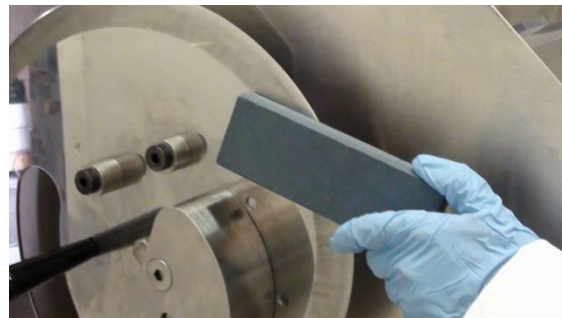

Fig: H3

The hone process is quite simple.

The rear bevel of the knife is honed first.

Place the stone at a zero degree of angle, as parallel to the angle of the rear of the knife as possible, and as far behind the knife as is safe.

Draw the stone out toward the operator.

While drawing the stone toward the operator slowly rotate the knife in either direction

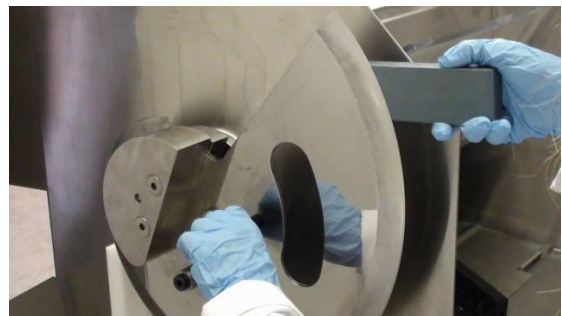

Fig: H4

Be sure to hone while rotating, hone while rotating until the entire rear of the knife edge has been honed.



Fig: H5

Repeat the process twice.



Fig: H6

Next Hone the the front bevel.

Note that the front bevel is at a 15 degree angle.

Place the stone at the 15 degree angle, as parallel to that angle of the knife as possible.

Be safe.

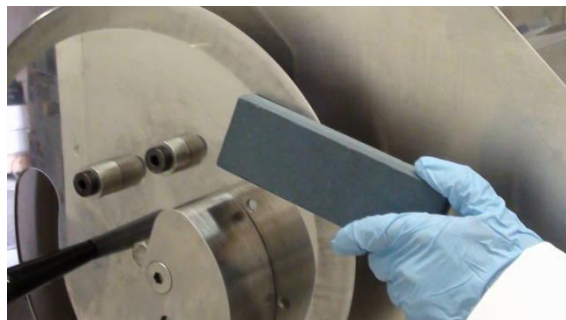

Fig: H7

Be sure to rotate and hone, rotate and hone until the entire front of the knife edge has been honed.

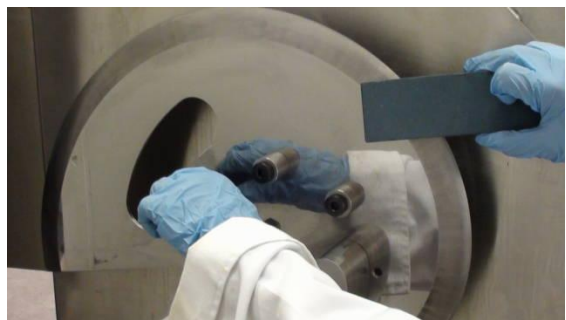

Fig: H8

Repeat the process a second time.

If you must you can test for sharpness by using a sheet of paper and slicing through the side edge.

CLEAN AND SANITIZE ALL SURFACES

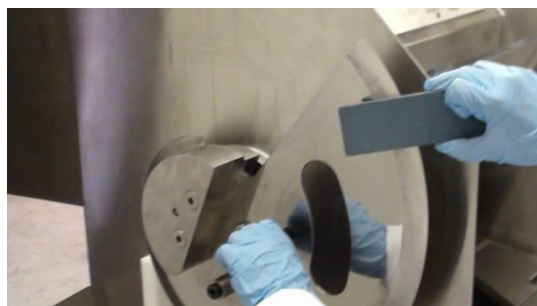

Fig: H9

## Lubrication

### LUBRICATE AT LEAST ONCE PER MONTH!

Depending on your slicer model there are either two (2) or four (4) parallel linear shafts. These shafts are located inside the main weldment which can be accessed through the rear panel. In addition the feed drive ball screw is located within a stainless steel guard, the cover of which is accessed by removing the top.

LUBRICATE THE PARALLEL SHAFTS AT LEAST ONCE PER MONTH.

LUBRICATE THE BALL SCREW AT LEAST ONCE PER MONTH.

The frequency of lubricating the machine depends on the amount of use. Lubrication to the parallel shafts can occur as frequently as every day under extremely heavy use. Lubricate the 2 or 4 parallel linear shafts at least once per month and at any time that pushing the feed drive arm becomes difficult. Use a 3:1 type oil or a food safe lubricant; do not use cooking oil.

We recommend that only Alvinia Grease S2 or equal EP2 Lithium bearing grease

1. Press the E stop switch. Unplug the machine to disconnect the power supply.
2. Remove the mechanical cover located at the rear of the machine.
3. Locate, clean and lubricate the 2 or 4 internal linear shafts (depending on the model).
4. Lubricate the feed drive ball screw using the Alvinia GreaseS2 or equal EP2 Lithium lubrication.
5. Lubricate the parallel linear shaft using a commercial light weight food grade oil.
6. Carefully replace the mechanical cover located at the rear of the machine.

## The E Stop Switch

The E-stop switch must be pushed and activated when cleaning or servicing.

The Power Cord must be unplugged from the outlet when cleaning or servicing.

Prior to resetting the E-stop the operator must ensure the machine is in a safe condition. Inspect the slicer. Reset the Emergency stop switch located on the front of the machine only after it is safe to do so.

Inspecting the Slicer:

„ Inspect that the slicer is working properly and in good condition before each use or at least every six months.

„ If the slicer is not functioning properly do not use it. Have the equipment serviced by an authorized Dx Industrial slicer service agency.

„ All seals are to be inspected by qualified personnel a minimum of every six months. If any seal is faulty, do not use it. Have the equipment serviced by an authorized Delix service agency.

**Note:** „ The sanitizer concentration shall comply with Section 4-501.114, Manual and Mechanical Warewashing Equipment, Chemical Sanitization – Temperature, pH, Concentration, and Hardness of the FDA Food Code. „If a chemical sanitizer other than chlorine, iodine or quaternary ammonium is used, it shall be applied in accordance with the EPA registered label use instructions. This slicer shall be cleaned and sanitized at intervals to comply with national, state and/or local health codes. „This slicer shall be cleaned and sanitized each time the knife is sharpened.

## LIABILITY STATEMENT:

Purchaser is required, within 30 days of delivery of the slicer, to provide a certificate of insurance in the minimum amount of \$500,000 (five hundred thousand dollars) indemnifying Anco Slicing Inc and the Dx Industrial Slicing Company from any and all liability from the use of the slicing machine and any additional components. This certificate will name Anco Slicing Inc and Dx Industrial Slicing Company as “also insured” and place said insured entity in the primary position in any claim action, including, but not limited to all legal fees associated with any action. It is the responsibility of the purchaser to maintain a safety officer in their facility. It is the responsibility of the purchaser to assign and train any employee authorized to use slicer. It is the responsibility of the purchaser to store the slicer in a safe and secure location in their facility to insure no unauthorized individual may gain access to the machine.

LIMITED WARRANTY STATEMENT FOR THE Dx Industrial Slicing Co, Inc. This warranty does not apply to products purchased for personal, family or household use, and The Dx Industrial Slicing Co, Inc. does not offer a written warranty to purchasers for such uses. The Dx Industrial Slicing Co.warrants the products it manufactures or distributes against defects in materials and workmanship for a period of six (6) months, except as specifically described in our full warranty statement. This warranty extends to parts only. No on site service or customer plant visits are included. Warranty excludes labor. Plant visits to repair or replace parts or to change programming will be billed at additional expense to the purchaser. In all cases, the warranty runs from the date of the end user’s original purchase date found on the receipt. Any damages from improper use, abuse, modification or damage resulting from improper packaging during return shipment for warranty repair will not be covered under warranty. For complete warranty information, product registration and new product announcement, visit [www.dxslicer.com](http://www.dxslicer.com).

## Some Tips Before Starting

- **Always** wear protective gloves. Cut-resistant gloves like cut-proof metal gloves are the ideal option, especially when handling the blade.
- **Always** follow the manufacturer's instructions exactly.
- **Never** use steel wool because it can scratch the machine.
- **Never** submerge the slicer completely. Your slicer's manual will specify which parts are dishwasher safe and how to care for others.

## Why It's Important to Clean a Meat Slicer

Slicers are used for a variety of food items including raw and cooked meats, cheese and produce. When you don't regularly clean your slicer, food residue can build up in parts of the machine, causing bacteria to grow. This bacteria can contaminate foods and cause foodborne illnesses, which can make customers very ill! In addition, a meat slicer can transfer flavors or small food particles onto items you slice later, altering the pure taste or texture of your products.

## Specific Problem Areas

Carefully inspect all food contact areas, knife guard, and slicer trays on your meat slicer for any cracks, broken, or missing or unattached parts. Food particles can accumulate inside your knife guards, and in food contact areas. When food collects, it can breed and harbor dangerous bacteria.

Make sure you regularly examine the seams, seals, and gaskets on your machine to see if they've worn away and created additional cracks and crevices where food and bacteria can accumulate. You should never use a slicer that has missing, broken, unattached, or defective seals, seams, or gaskets. Remove this slicer from service and repair it before using it, as there may be dangerous trapped bacteria.

# When to Clean Meat Slicer

You should always wipe your slicer down when switching meats, cheeses, or produce. It's a good idea to fully clean your machine every day to prevent oils and solid food pieces from building up on your blade or face plates and harboring potentially dangerous bacteria. The FDA actually recommends cleaning meat slicers every 4 hours if they're being used continuously, so you should clean your machine as frequently as possible.

## Slicer Tips: Before Starting

### Keep the Knife Sharp

Sharp knives are the key to having evenly sliced meats and cheeses. Knives that have become dull can make the meat seem somewhat minced or rough because the dull knives don't cut through the meat in the same way as sharp knives. The shredding that can occur with dull knives won't produce the quality of deli cuts that your customers expect from your company.

It is imperative that you use proper procedures when you are working on your Dx Industrial Slicer. Your owner's manual will provide important information on how to safely maintain your slicer.

For example, when the knife is being changed, sharpened, or used, the person who is operating the unit should wear cut-resistant gloves. This helps keep the user safe from injury and also helps you keep in compliance with the Occupational Health and Safety Administration's regulations that help ensure a safe workplace.

### Check the Settings

Consistency is the key when you are making sandwiches and other dishes. Making sure that settings on the Dx slicer are properly set can help ensure that the consistency remains. Even slight differences in the thickness of a cut can significantly alter the delicate balance of flavors that you have created in a dish.

It is a good idea to check the thickness setting each time you start the machine, even if the meat or cheese you are cutting is the same as the previous job. You should also check the first cut that comes off the meat or cheese when you first start a job. Once you verify that the first cut is what you need, you can move forward with the remaining slices.

## Proper Food Safety

Proper food safety practices must be followed each time you use the Dx Industrial slicer. Failing to follow proper safety practices can cause people who consume the meats and cheeses that you slice to become ill. In fact, slicing equipment that isn't properly cleaned and sanitized is one cause of food borne illnesses that the United States Food and Drug Administration recognizes as a problem.

One way you can ensure that proper food safety practices are being used is to have the slicers marked to let employees know what to use the slicer for. If possible, don't use the same slicer for cooked meats and raw meats. Even if you are cleaning the slicer after each use, there is still a chance of cross- contamination.

## Clean the Unit After Each Use

Now that you are aware that you must practice safe food handling procedures, you probably realize how important it is to keep the Dx Industrial Slicer clean. It isn't enough to simply wipe the unit down. Instead, it must be cleaned to ensure that areas that might accumulate food soil are clean. There are some specific areas that you must double check when you clean your Dx Industrial Slicer.

The food contact area, product feed area and knife guard are three areas of slicers that the FDA warns should be checked for food residue. When you check these parts of the slicer, make sure that you look for loose, cracked, or damaged areas since food soil and debris can be harbored there.

Besides cleaning the slicer after each use, the FDA recommends that slicers be sanitized and cleaned every four hours. This helps to remove pathogens that can lead to outbreaks of foodborne illnesses. Each Dx Industrial Slicer has a manual that details how you should clean and sanitize the unit. Keeping that manual near the workstation can make it easier for the person who is doing the job to properly complete the procedure.

### Sources:

<https://www.fda.gov/Food/GuidanceRegulation/RetailFoodProtection/IndustryandRegulatoryAssistanceandTrainingResources/ucm240666.htm>

<https://www.osha.gov/Publications/OSHA3794.pdf>



## Safety Features You Should Know About

SAFETY FEATURES YOU SHOULD KNOW ABOUT	
<i>START PUSH BUTTON</i>	<i>START BUTTON REQUIRES THAT THE OPERATOR PRESS AND HOLD FOR ONE FULL SECOND.</i>
<i>KNIFE GUARD HAND KNOB</i>	<i>KNIFE GUARD MUST BE CLOSED AND THE KNIFE GUARD KNOB MUST BE TIGHTENED FULLY</i>
<i>FEED DOOR</i>	<i>FEED DOOR MUST BE CLOSED FOR MACHINE OPERATION</i>
<i>E-STOP / UNPLUG THE MACHINE</i>	<i>THE E-STOP</i>
<i>A NOTE ABOUT THE (2) SAFETY SENSORS</i>	<i>NOTE: BOTH SAFETY SENSORS HAVE AN LIGHT ON THE PROX. IF THE LIGHT IS LIT THE SENSOR IS ENGAGED</i>
<i>OVERLOAD</i>	<i>SEE "SAFETY FEATURES WHICH EFFECT OPERATION" PAGE 11</i>

## Troubleshooting

### Technical support (309) 590-0300 Ext #1

PROBLEM	POSSIBLE CAUSE	SOLUTION
MACHINE WILL NOT START	KNIFE SAFETY SENSOR IS NOT CLOSED	SCREW IN THE KNIFE GUARD HAND KNOB TIGHTLY
	FEED DOOR IS NOT CLOSED	CLOSE THE FEED DOOR
	<i>NOTE: BOTH SAFETY SENSORS HAVE AN LED LIGHT ON THE SENSOR ITSELF. IF THE LIGHT IS LIT THE SENSOR IS ENGAGED</i>	
	E-STOP IS PRESSED	RELEASE THE E-STOP
	A FAULT HAS BEEN TRIPPED	CYCLE THE POWER
MACHINE FEED ARM IS STUCK	BELT SLIP, OVERLOAD	SEE "SAFETY FEATURES WHICH MAY AFFECT OPERATION" SECTION PAGE 11
MACHINE STARTS BUT FEED ARM DOES NOT OPERATE	NOT ENOUGH TIME BETWEEN CLOSING THE FEED DOOR AND PRESSING START	PRESS AND HOLD STOP FOR 2 SECONDS
I PRESS START BUT NOTHING HAPPENS	YOU CLOSED THE FEED DOOR AND PRESSED START TOO SOON THE FEED DOOR RESETS THE CONTROLLER WHICH TAKES A SECOND TO REBOOT	PRESS AND HOLD THE STOP PUSHBUTTON
MACHINE DOES NOT OPERATE	OBSTRUCTION	CHECK FOR OBSTRUCTIONS IN THE FEED BED AREA. CHECK TO SEE THAT THE FEED ARE IS BEHIND THE HOLD DOWNS.
KNIFE SOUNDS LIKE IT IS HITTING SOMETHING	SHEAR EDGE NOT INSTALLED PROPERLY	TIGHTEN THE SHEAR EDGE. RE-INSTALL THE SHEAR EDGE
EXCESSIVE VIBRATION	<p>INVOLUTE KNIVES ARE INHERENTLY UNBALANCED PARTICULARLY AT CERTAIN SPEEDS. IT IS JUST PHYSICS.</p> <p>TO REDUCE VIBRATION: SECURE THE SLICER TO PLATFORM ON A FIXED FLAT SURFACE</p> <p>BALANCING WEIGHTS MIGHT BE ADDED. CONSULT WITH DX INDUSTRIAL</p>	

THIS PAGE INTENTIONALLY LEFT BLANK

# APPENDIX A

## A SLICING GUIDE

Slicing with a Dx Industrial Slicer. A guide.  
Successful High Volume Slicing requires considering all of the following factors:

The machine operation:

- Place your Product on the Feed Bed
- Select the Slice Thickness
- Close the Safety Cover
- Press Start

The machine will slice the product to the thickness selected, stop and return to the "home" position.

Safe, Fast, Affordable Slicing.

### Bacon, Cured, Smoked

Must be Frozen. 22-24 Degrees.

Understand the Issue.

The slicer will slice anything you put in it.

The slicer doesn't know nor does it care.

Sliced too warm the bacon will be thrown to one side and not lay down properly.

In addition, once sliced the bacon will be impossible to move.

Sliced, frozen bacon is quite easy to collect and transfer to a tray, card or paper.

To start, freeze the bacon overnight. Place the frozen belly on the slicer and slice the first inch or so. Press the stop button. If the slices are "flaked" or are cracking they are too cold. If so, put the belly into a cooler. Bring the temperature up for one or two hours or more, slicing and testing as the belly warms. Shortly you will have the perfect slice which "lays down" well and can be transferred after slicing to a card, paper, tray or directly into a vacuum unit.

Now, **WRITE DOWN YOUR PROCEDURE** and instruct your employees.

Consistency is key to successful high volume slicing.

## Raw Meats

Slice all raw meats frozen. Typically from 10- 27 Degrees.

A clean consistent slice requires that raw meats be frozen. Raw, warm product will move when sliced making it impossible to maintain a consistent slice.

Eye of round sliced to 3/16" thickness fully frozen will result in a good, consistent slice with the entire product sliced in under 25 seconds.

HINT: How each product being sliced will behave.

This depends on several factors.

Control the product going into the slicer and you control the sliced product coming out of the slicer.

### Variables include:

- Is the product raw, cooked or cured?
- Is the product frozen, chilled or right out of the oven.
- The density of the product
- The fat content of the product
- Is it water added or a smoked product?
- Consistency in regard to shape.

## Cooked Beef, Corned Beef, Peppered Beef

Slice chilled. Typically no need to freeze.

Typically cannot be sliced warm just from the oven. If warm the beef tends to shred.

Cooked beef, rounds, briskets, flats are sliced nicely with good lay down.

## Cheese or Processed Cheese

Slice directly from the cooler. Shingle or stack.

HINT: Stacking is best achieved by removing the conveyor. Place a deep lug or tray at the discharge side of the slicer. Slice. The cheese product will stack into the trays. the deeper the tray, the taller the stack.

Drop the tray for taller stacks.

The conveyor is only needed if shingling is required.

## What happens after being sliced? How do you move the sliced product?

- After the slice the product needs to be packaged.
- Frozen sliced products can more easily be moved and packed.
- Shaved product can be transferred at a wider temperature range if sliced into tubs
- Stacking is more easily achieved if the receiving tray is 12" plus lower than the shear edge.
- Slice into a tray or onto a conveyor.

Each product is different. Play with it. Learn the best way for your transfer needs.

EXAMPLE: IF YOU SLICE BACON WARM YOU DO NOT GET SLICED BACON.  
YOU GET COOKED SPAGHETTI WHICH CANNOT BE EASILY MOVED.

## Shingle vs. Stacking vs Slicing in Bulk

- Slice onto a conveyor for shingled products.
- Slice into a tray for stacking. The farther the tray is below the shear edge the higher the stack.
- Slice onto a conveyor for horizontal stacking. Frozen sliced products can then be scooped up for packaging.
- Slice into a tray, lug or wheeled cart for high volume shaving.

There are many ways to achieve your desired slicing results.

## Slicing Larger Product. Buffet Hams and Full Turkey Breast

Are best sliced on the Dx3000 with the dropped shear edge.

Buffet hams as well as full round turkey breast.

Slice frozen for a consistent slice thickness.

Slice warmer if shaving.

Test your product.

## HINT: Slicing Larger Inconsistent Shapes

Problem: The last 1" of the product may not slice consistently because of the shape. It may be pulled through the knife.

Solution: Change the automatic settings to stop slicing 1" before the edge.

Then slice all the "rework" on a smaller deli slicer all at once.

The slicer may lose control of larger products which are formed in a mold and which are rounded at the front and back end of the product. Control may be lost of the last inch and be pulled through the machine. The solution is to stop slicing about an inch before the edge and "rework" or slice the product on a smaller deli type slicer.

This stopping action of the feed arm can be made automatic through the use of the rotary dial.

## Deli Meats and Cheese-There is no Magic Slicing Button!

Dx Industrial Slicers offers a full range of deli slicing machines each of which is designed to slice a specific size and shape of product. Just as with conventional deli slicers there is a wide variety of slicers available each suited to different products and needs. Our slicers are no different. When choosing a slicer, always consider such factors as the size of your product, the size of each slicer's feed opening, the length of your product, your packaging needs after the product has been sliced and the volume of product you intend to slice. Understand that you may need more than one slicer to achieve all of your slicing goals.

### Salami, Sausage, Soppressata, Pepperoni

Best sliced on any of our slicers. Check feed opening specifications for larger diameters.

This product can be sliced at warm temperatures or frozen and is quite stable in regard to a consistent slice thickness.

Best sliced thin. The density of this product may cause the slicer to refuse to slice at thicker settings.

### Vegetables

Many vegetables can be sliced on our line of slicers.

Each behaves in its own way.

## SLICING HINT: Using the programmable slice thickness dial.

This control can be programmed to 15 functions. Functions include slice thickness and the distance which the feed arm travels. Typically the slice thickness is from thin to thick but this control can be changed to slice specific products such as a setting "roast beef" at a thickness with the next preset being "cheese" at a different thickness. In addition these presets can stop an unusually shaped product an inch short of the shear edge to save product from being pulled through the slicer and allowing for "rework" of the product.

### No Bone in Product of any Kind !

The bone will shatter causing injury to any customer who consumes it.

### Do not attempt to slice anything thicker than 1/4".

We do offer slicers for thicker products but these are only custom fabrications.

Stock slicers are designed for thin slicing.

APPENDIX B  
CHANGING THE SLICE THICKNESS  
ORIENTAL CONTROLLER PROGRAMMING



## Programming of the Controller

### Oriental Controllers only

#### Changing Slice Thickness All Models Through May 2022

##### 1) Download the Software

Visit [www.orientalmotor.com](http://www.orientalmotor.com)

On the home page find DOWNLOADS

SOFTWARE

MEXEO2

DOWNLOAD THE SOFTWARE

This will require that you register for the site.

The will come in a zipped format,

EXTRACT THE PROGRAM AND LOCATE ON YOUR DESKTOP

##### 2) Attach the laptop to the Controller using the USB cable

Turn on the DX Slicer

Establish communication

Save the existing program

Product to PC save in a backup location

<https://www.orientalmotor.com/support/software/SFTWR/HM-60131-7E.pdf>

Download the manual to change slice thickness

**Download the Software.**  
Windows ver. 8-10

COMPATIBLE WITH MICROSOFT  
PRODUCTS ONLY !

You will first need to register your  
business with Oriental Motor.

- 1) Go to:  
www.orientalmotor.com

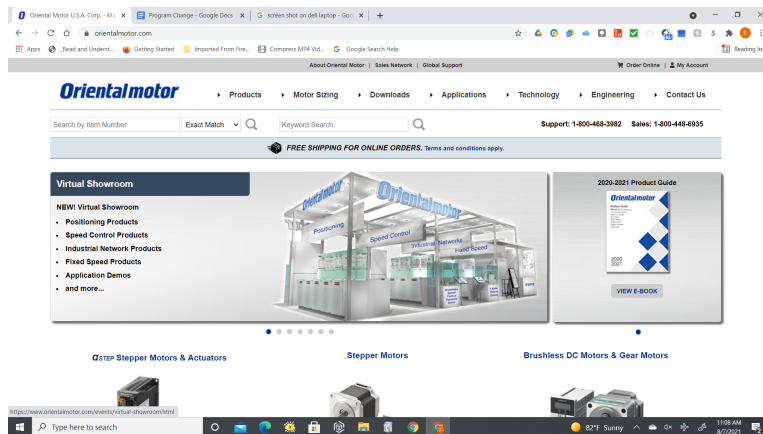

- 2) Choose Downloads
- 3) Choose Software

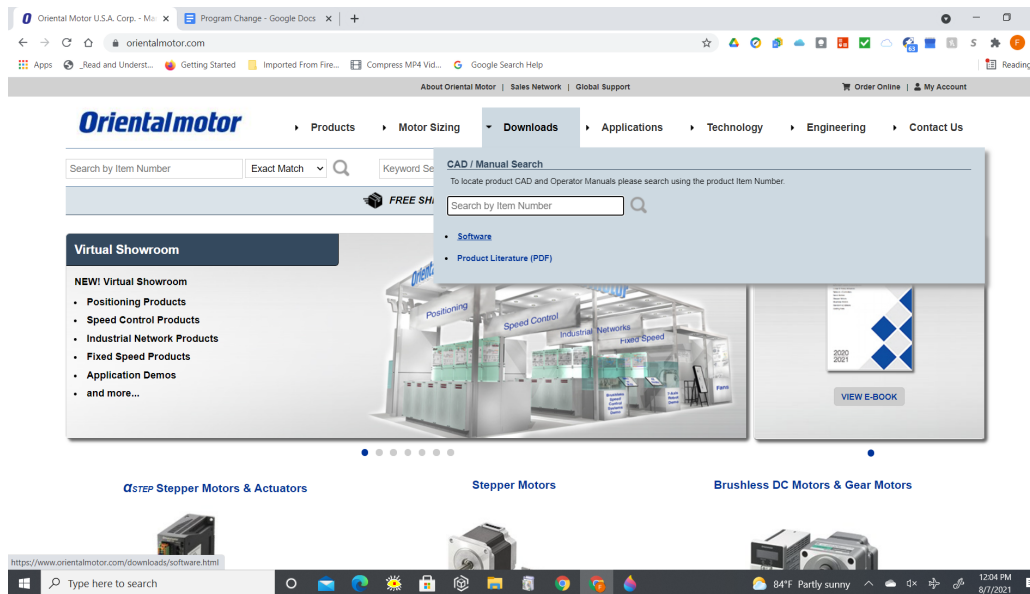

4) Register your business and Submit

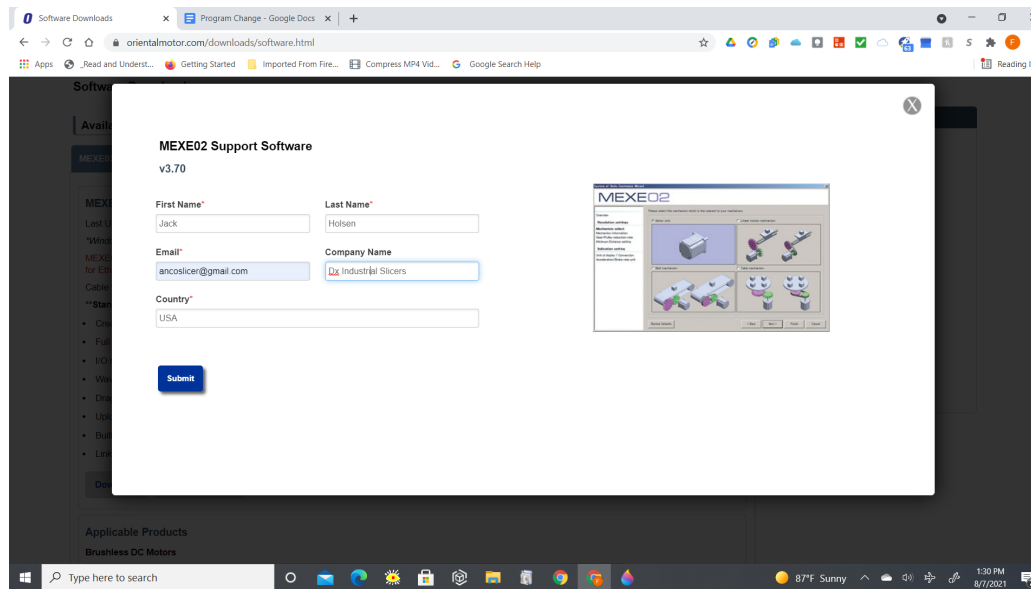

- 5) Choose Download and follow the instructions.
- 6) Accept all.
- 7) Locate the MEXE02 Software icon. It is typically in your desktop or downloads file.
- 8) Choose Download and follow the instructions.
- 9) Accept all.
- 10) Locate the MEXE02 Software icon. It is typically in your desktop or downloads file

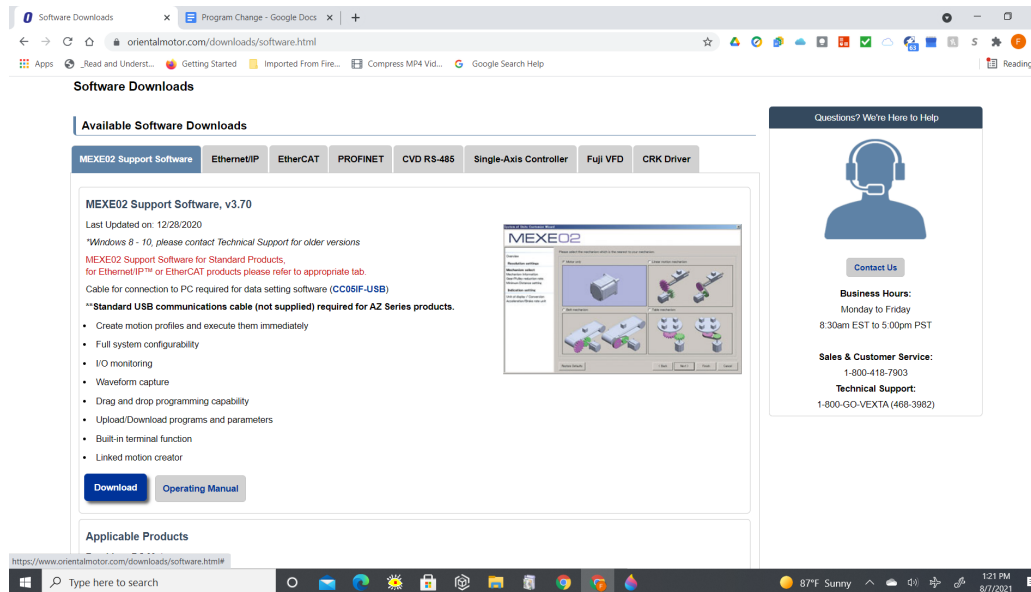

## Open the Software and Connect to the Machine

- Power up the slicer.
- Locate the USB cord inside the right side mechanical door.
- Attach the USB to your laptop.
- Open the MEXEO 02 Software
- Press “Data reading (Product-PC)”

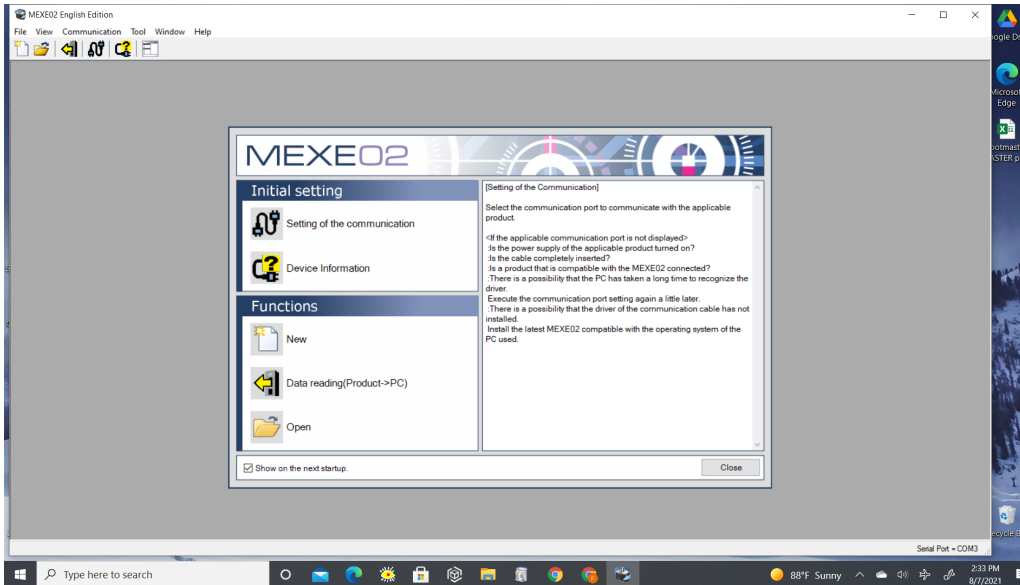

The operation data page will appear.

- This is the operating program on your machine.
- **SAVE THIS PROGRAM TO YOUR DESKTOP BEFORE YOU MAKE CHANGES !**
- Choose File, save as...  
Locate this on your Desktop

This will become your backup program file.

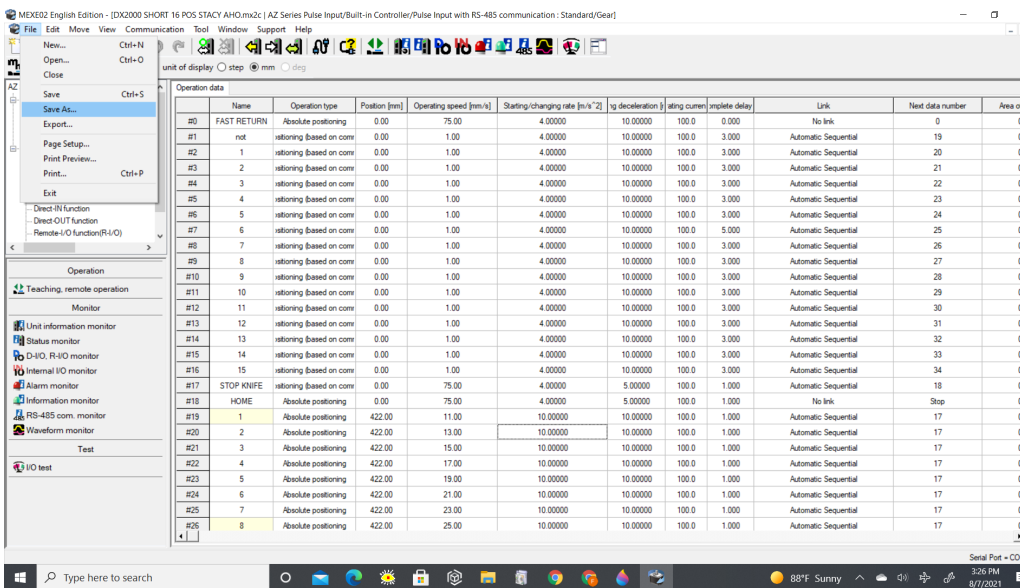

## To change slice thickness:

- Locate the column "Operating Speed (mm/s)
- Scroll down to lines #19 to #34
- These numbers are the thickness settings.
- They represent the speed at which the feed arm advances.
- Each line references the 15 positions of the slice thickness dial on the control panel on the front of the machine.

### PARAMETERS:

- The lower the number the slower the advance, the thinner the slice.
- Values must be between 1-50

### HINT:

- 1 is tissue paper 30 is pretty thick
- Highlight each box and type in the value
- Values can be 100/th of an inch (ex: 14.25) but typically are whole numbers.

Name	Operation type	Position [mm]	Operating speed [mm/s]	Starting/changing rate [m/s <sup>2</sup> ]	g deceleration	string cume	complete delay	Link	Next data number	
#9	8	stationing based on com	0.00	1.00	4.00000	10.00000	100.0	3.000	Automatic Sequential	27
#10	9	stationing based on com	0.00	1.00	4.00000	10.00000	100.0	3.000	Automatic Sequential	28
#11	10	stationing based on com	0.00	1.00	4.00000	10.00000	100.0	3.000	Automatic Sequential	29
#12	11	stationing based on com	0.00	1.00	4.00000	10.00000	100.0	3.000	Automatic Sequential	30
#13	12	stationing based on com	0.00	1.00	4.00000	10.00000	100.0	3.000	Automatic Sequential	31
#14	13	stationing based on com	0.00	1.00	4.00000	10.00000	100.0	3.000	Automatic Sequential	32
#15	14	stationing based on com	0.00	1.00	4.00000	10.00000	100.0	3.000	Automatic Sequential	33
#16	15	stationing based on com	0.00	1.00	4.00000	10.00000	100.0	3.000	Automatic Sequential	34
#17	STOP KNIFE	stationing based on com	0.00	75.00	4.00000	5.00000	100.0	1.000	Automatic Sequential	18
#18	HOME	Absolute positioning	0.00	75.00	4.00000	5.00000	100.0	1.000	No link	Stop
#19	1	Absolute positioning	422.00	11.00	10.00000	10.00000	100.0	1.000	Automatic Sequential	17
#20	2	Absolute positioning	422.00	13.00	10.00000	10.00000	100.0	1.000	Automatic Sequential	17
#21	3	Absolute positioning	422.00	15.00	10.00000	10.00000	100.0	1.000	Automatic Sequential	17
#22	4	Absolute positioning	422.00	17.00	10.00000	10.00000	100.0	1.000	Automatic Sequential	17
#23	5	Absolute positioning	422.00	19.00	10.00000	10.00000	100.0	1.000	Automatic Sequential	17
#24	6	Absolute positioning	422.00	21.00	10.00000	10.00000	100.0	1.000	Automatic Sequential	17
#25	7	Absolute positioning	422.00	23.00	10.00000	10.00000	100.0	1.000	Automatic Sequential	17
#26	8	Absolute positioning	422.00	25.00	10.00000	10.00000	100.0	1.000	Automatic Sequential	17
#27	9	Absolute positioning	422.00	27.00	10.00000	10.00000	100.0	1.000	Automatic Sequential	17
#28	10	Absolute positioning	422.00	29.00	10.00000	10.00000	100.0	1.000	Automatic Sequential	17
#29	11	Absolute positioning	422.00	31.00	10.00000	10.00000	100.0	1.000	Automatic Sequential	17
#30	12	Absolute positioning	422.00	33.00	10.00000	10.00000	100.0	1.000	Automatic Sequential	17
#31	13	Absolute positioning	422.00	35.00	10.00000	10.00000	100.0	1.000	Automatic Sequential	17
#32	14	Absolute positioning	422.00	37.00	10.00000	10.00000	100.0	1.000	Automatic Sequential	17
#33	15	Absolute positioning	422.00	39.00	10.00000	10.00000	100.0	1.000	Automatic Sequential	17
#34	16	Absolute positioning	422.00	41.00	10.00000	10.00000	100.0	1.000	Automatic Sequential	17
#35		stationing based on com	0.00	0.00	5.00000	5.00000	100.0	1.000	Automatic Sequential	17

**IMPORTANT: Do not enter any value other than 1-50. Higher values may damage the machine.**

**Next: Write the program to the**

## Controller

You have just made changes to the slice thickness .

- You must now “Write” this program to the controller.
- Choose the “Write” icon
- Accept all

The screenshot shows the 'AZ Series Pulse Input/Built-in Controller/Pulse Input with RS-485 communication' window. The 'Operation data' table is as follows:

#	Name	Operation type	Position [mm]	Operating speed [mm/s]	Starting/charging rate [mm/s <sup>2</sup> ]	g(deceleration)	ring current	plate delay	Link	Next data number	Area
#0	FAST RETURN	Absolute positioning	0.00	75.00	4.00000	10.00000	100.0	0.000	No link	0	
#1	not	istioning Based on com	0.00	1.00	4.00000	10.00000	100.0	3.000	Automatic Sequential	19	
#2	1	istioning Based on com	0.00	1.00	4.00000	10.00000	100.0	3.000	Automatic Sequential	20	
#3	2	istioning Based on com	0.00	1.00	4.00000	10.00000	100.0	3.000	Automatic Sequential	21	
#4	3	istioning Based on com	0.00	1.00	4.00000	10.00000	100.0	3.000	Automatic Sequential	22	
#5	4	istioning Based on com	0.00	1.00	4.00000	10.00000	100.0	3.000	Automatic Sequential	23	
#6	5	istioning Based on com	0.00	1.00	4.00000	10.00000	100.0	3.000	Automatic Sequential	24	
#7	6	istioning Based on com	0.00	1.00	4.00000	10.00000	100.0	5.000	Automatic Sequential	25	
#8	7	istioning Based on com	0.00	1.00	4.00000	10.00000	100.0	3.000	Automatic Sequential	26	
#9	8	istioning Based on com	0.00	1.00	4.00000	10.00000	100.0	3.000	Automatic Sequential	27	
#10	9	istioning Based on com	0.00	1.00	4.00000	10.00000	100.0	3.000	Automatic Sequential	28	
#11	10	istioning Based on com	0.00	1.00	4.00000	10.00000	100.0	3.000	Automatic Sequential	29	
#12	11	istioning Based on com	0.00	1.00	4.00000	10.00000	100.0	3.000	Automatic Sequential	30	
#13	12	istioning Based on com	0.00	1.00	4.00000	10.00000	100.0	3.000	Automatic Sequential	31	
#14	13	istioning Based on com	0.00	1.00	4.00000	10.00000	100.0	3.000	Automatic Sequential	32	
#15	14	istioning Based on com	0.00	1.00	4.00000	10.00000	100.0	3.000	Automatic Sequential	33	
#16	15	istioning Based on com	0.00	1.00	4.00000	10.00000	100.0	3.000	Automatic Sequential	34	
#17	STOP KNIFE	istioning Based on com	0.00	75.00	4.00000	5.00000	100.0	1.000	Automatic Sequential	18	
#18	HOME	Absolute positioning	0.00	75.00	4.00000	5.00000	100.0	1.000	No link	Stop	
#19	1	Absolute positioning	422.00	19.00	10.00000	10.00000	100.0	1.000	Automatic Sequential	17	
#20	2	Absolute positioning	422.00	21.00	10.00000	10.00000	100.0	1.000	Automatic Sequential	17	
#21	3	Absolute positioning	422.00	23.00	10.00000	10.00000	100.0	1.000	Automatic Sequential	17	
#22	4	Absolute positioning	422.00	25.00	10.00000	10.00000	100.0	1.000	Automatic Sequential	17	
#23	5	Absolute positioning	422.00	19.00	10.00000	10.00000	100.0	1.000	Automatic Sequential	17	
#24	6	Absolute positioning	422.00	21.00	10.00000	10.00000	100.0	1.000	Automatic Sequential	17	
#25	7	Absolute positioning	422.00	23.00	10.00000	10.00000	100.0	1.000	Automatic Sequential	17	
#26	8	Absolute positioning	422.00	25.00	10.00000	10.00000	100.0	1.000	Automatic Sequential	17	

**Run the Machine** to see if the changes are what you want.

- If the speed changes are good then you are done.
- If you want to make more changes simply enter a different number.
- Be sure to “Write” any changes to your controller after you are done.

Once written the values are saved automatically.

**NOTE:**

- Once you have made changes you must save the new program to the machine AND keep a copy of the changes for your own records.
- Do not overwrite the original Program. Save any new program under a different file name. Use the “save as” command

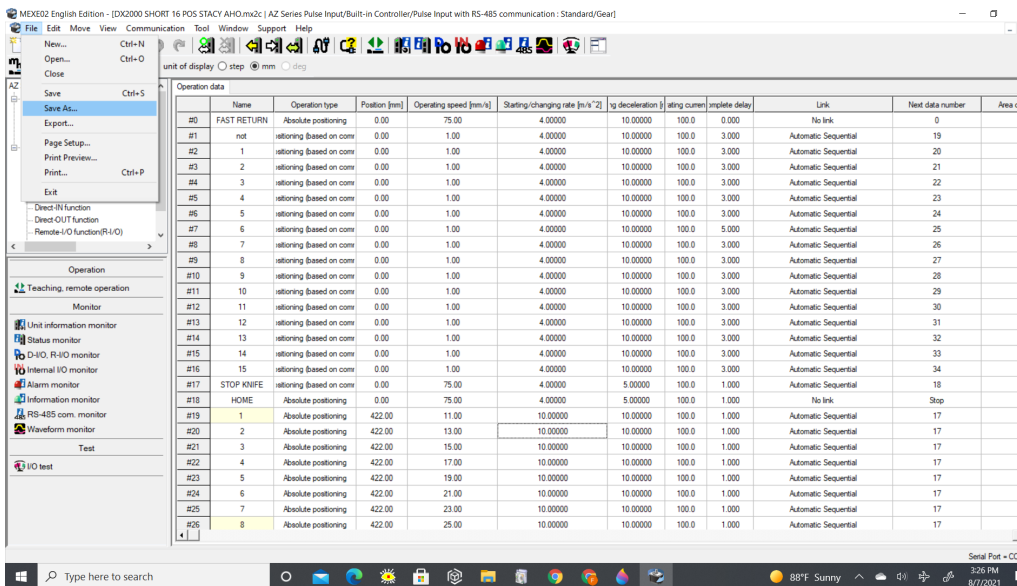

Other Important Icons:

“Setting of the Communication”

Will establish communication with the controller.

You will use this often.

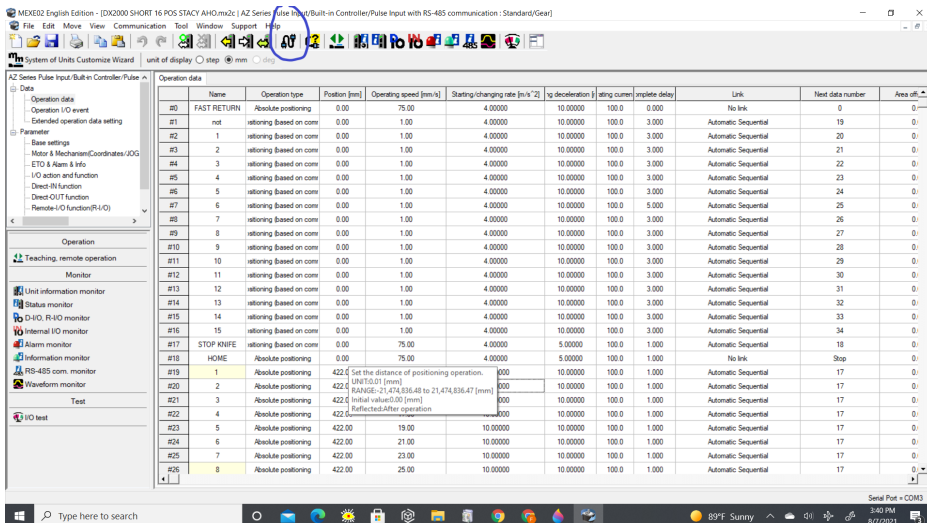

### “Data Verification”

After you have written the program to the controller you might want to verify that the data is correct.

This “Data Verification” Icon will compare your changes.

If they match a “very successful” will appear.

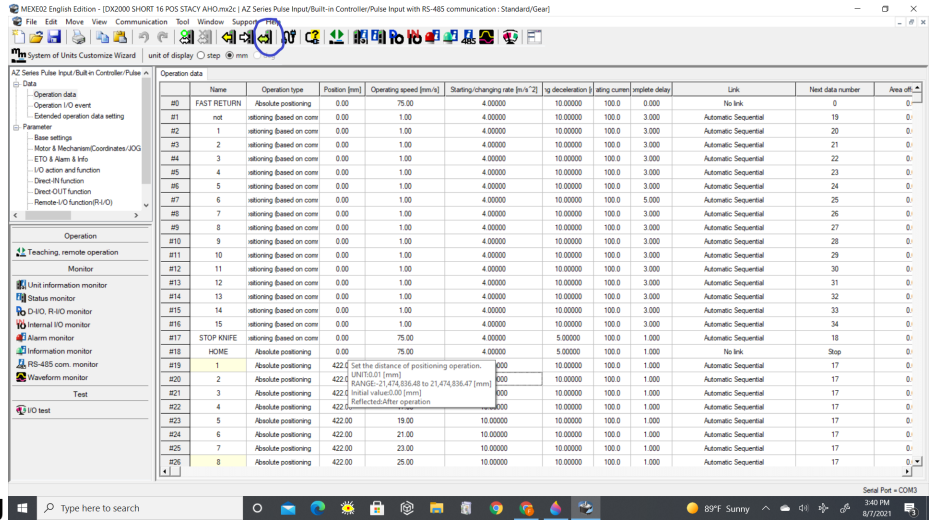

### “Data Reading”

This icon will read the program which exists on the controller.

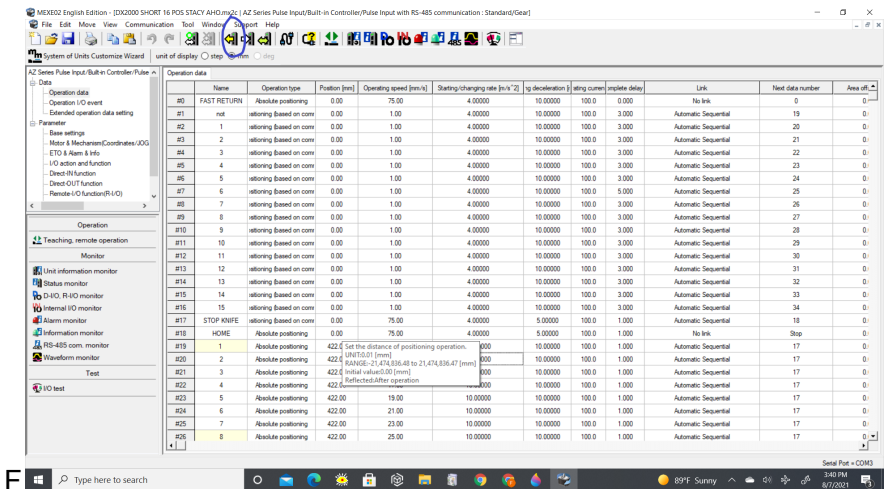



THIS PAGE INTENTIONALLY LEFT BLANK

APPENDIX C  
CHANGING THE SLICE THICKNESS  
APPLIED MOTIONS  
CONTROLLER PROGRAMMING  
BETA

**Download the Software.**

[Step-Servo Quick Tuner Setup 3.0.21.1120\(AMP\).exe](http://www.applied-motion.com/Products/Software/Step-Servo-Quick-Tuner-Setup-3.0.21.1120(AMP).exe)

COMPATIBLE WITH MICROSOFT PRODUCTS ONLY !

- 1) Go to: [www.applied-motion.com](http://www.applied-motion.com)

Choose: Support  
 Choose: Software Downloads

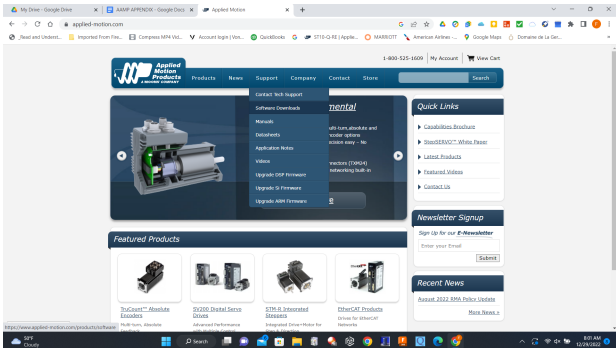

- 2) Choose: [Step-Servo Quick Tuner Setup 3.0.21.1120\(AMP\).exe](http://www.applied-motion.com/Products/Software/Step-Servo-Quick-Tuner-Setup-3.0.21.1120(AMP).exe)
- 3) Download and follow the instructions.
- 4) Click to Download and follow the instructions.
- 5) Accept all.

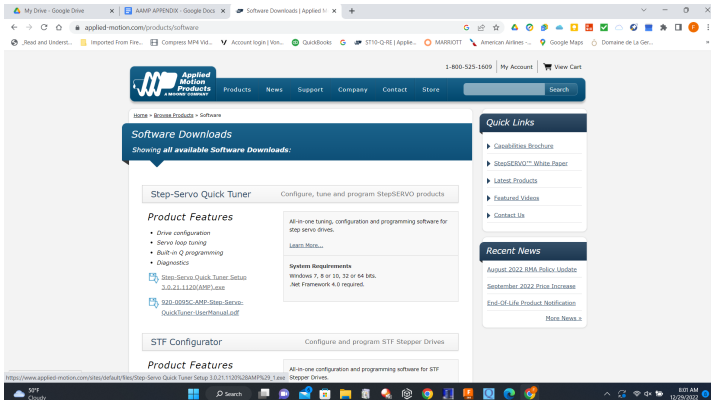

- 6) Locate the Step-Servo Quick Tuner 3 Software icon. It is typically on your desktop or in your downloads file

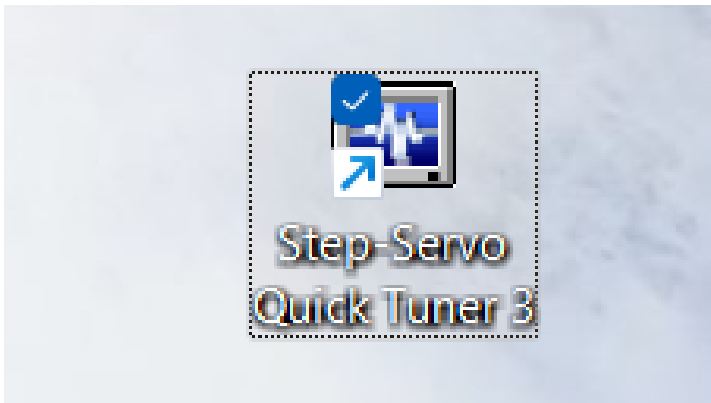

## Open the Software and Connect to the Machine

- Open the rear panel of the slicer
- Open the Electrical Panel
- Locate the Applied Motion Controller on the right side of the Electrical Panel
- Attach the Ethernet Cable to the Applied Motion Controller

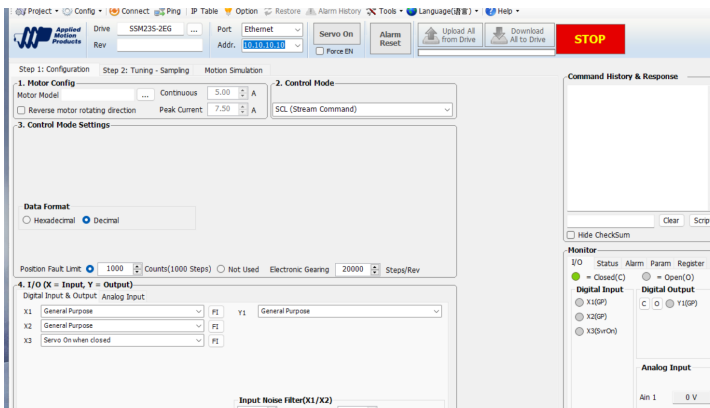

NOTE: Ethernet connection is located on the top or bottom of the Controller.

- Attach the Ethernet cable to your Laptop

- Power up the slicer.
- Open the Step Servo Software
- The controller should recognize the Step Servo program and automatically establish communication

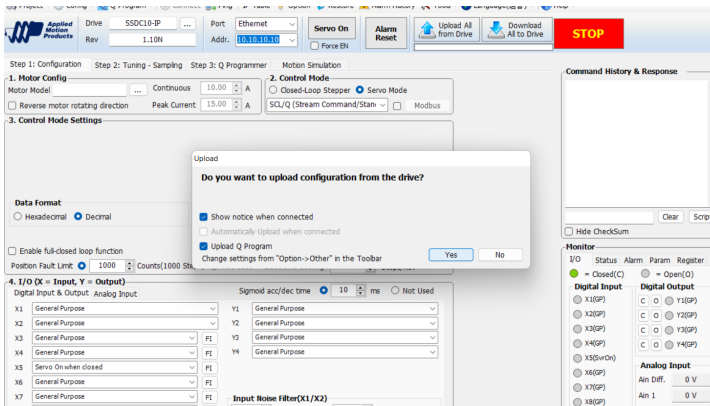

- Upload the existing program from the controller to your Step Servo Software.
- Choose "YES"
- Wait for the Software to finish loading. This may take a minute.

The operation data page will appear.

- This is the operating program on your machine.
- **SAVE THIS PROGRAM TO YOUR DESKTOP BEFORE YOU MAKE CHANGES !**
- Choose Project,
- Choose Save Project
- Name Your Original Project and Locate on your desktop

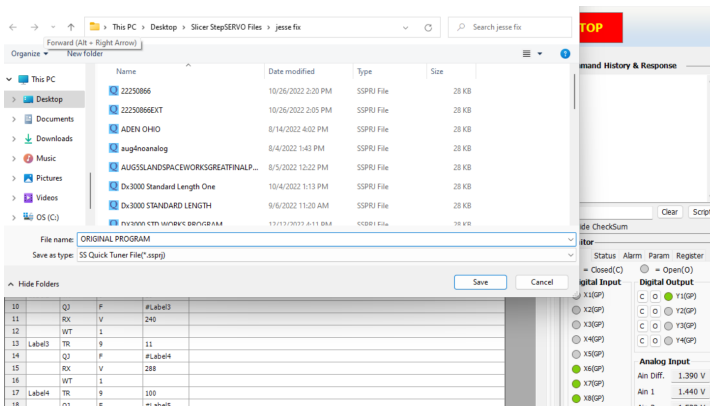

**This will become your backup program file.**

### To change slice thickness:

- Find tabs labeled Segment 1 to Segment 12
- Locate Segment 6 This is the slice thickness control for your slicer
- Locate the lines marked RX V ### This is typically on Line 3
- This is the first slice thickness for position one on the slice thickness dial.
- Change this number to change thickness
- Position 2 is Line 7
- Position 3 is line 11
- Position 4 is line 15
- Through to Position 16

#### PARAMETERS:

- The lower the number the slower the advance, the thinner the slice.
- Values must be whole numbers between 1-1,200

#### HINT:

- 100 is tissue paper 1,000 is pretty thick
- Highlight each box and type in the value
- Values are whole numbers only.

#### IMPORTANT:

- Any speed changes must be saved in Segment 6 and Segment 7 separately.
- Duplicate all changes in Segment 7
- Upload and save all changes.

**IMPORTANT: Do not enter any value other than 1-1,200.**

**Higher values may damage the machine.**

## Next: Download the new program to the drive.

You have just made changes to the slice thickness .

- You must now download this program to the controller.
- Choose the “Download all to drive” icon
- Accept all

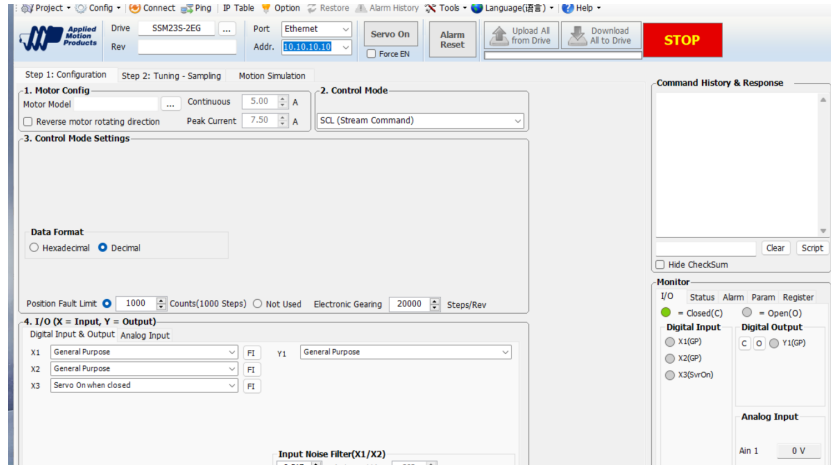

## Run the Machine to see if the changes are what you want.

- If the speed changes are good then you are done.
- If you want to make more changes simply enter a different number.
- Be sure to “Download all to Drive ” any changes to your controller after you are done.

### NOTE:

- Once you have made changes you must save the new program to the machine AND keep a copy of the changes for your own records.
- Do not overwrite the original Program. Save any new program under a different file name. Use the “save as” command

APPENDIX D  
LINKS TO  
ELECTRICAL SCHEMATICS

Visit [www.dx slicer.com](http://www.dx slicer.com)

Navigate to your products page Dx1000,Dx2000,Dx3000 or Conveyors

Electrical schematic links are located at the bottom of each page

# PARTS APPENDIX - DX1000

## PARTS LIST

### Wear Parts List: Dx1000

NOTE: THE FOLLOWING (3) PARTS SHOULD BE IN YOUR MAINTENANCE INVENTORY:

MAIN BELT	700-GBN750
DRIVE BELT	700-GBN477
MOTOR BRUSH (SET)	700-MTPM-1

NOTE: THE FOLLOWING WEAR PART NUMBERS ARE FOR YOUR FUTURE REFERENCE:

KNIFE	40199.000.K1	SAFETY RELAY (3)	700-HK32Z24
PIN GRIPPER 2 ½"	40152.003	THIN RELAY (5)	700-24 GSK
PIN GRIPPER 3 ½"	40152.004	PROX SENSOR (2)	700-PBM6-AP
SHEAR EDGE	40141.002	THICKNESS SWITCH	700-DPP01
		CODE LOCATED HERE ON EACH SERIAL DOC	



# PARTS APPENDIX - Dx2000

## PARTS LIST

### Wear Parts List: Dx2000

NOTE: THE FOLLOWING (3) PARTS SHOULD BE IN YOUR MAINTENANCE INVENTORY:

MAIN BELT	700-GBN750
DRIVE BELT	700-GBN504
MOTOR BRUSH (SET)	700-MTPM-1

NOTE: THE FOLLOWING WEAR PART NUMBERS ARE FOR YOUR FUTURE REFERENCE:

KNIFE	40299.000.K2	SAFETY RELAY (3)	700-HK32Z24
PIN GRIPPER	40252.005	THIN RELAY (5)	700-24 GSK
HOOK GRIPPER	40252.008	PROX SENSOR (2)	700-PBM6-AP
SHEAR LOWER	40241.002	THICKNESS SWITCH	700-DPP01
SHEAR UPPER	40241.003	CODE LOCATED HERE ON EACH SERIAL DOC	

# PARTS APPENDIX - Dx3000

## PARTS LIST

### Wear Parts List: Dx3000

NOTE: THE FOLLOWING (3) PARTS SHOULD BE IN YOUR MAINTENANCE INVENTORY:

MAIN BELT	700-GBN750
DRIVE BELT	700-GBN504
MOTOR BRUSH (SET)	700-MTPM-1

NOTE: THE FOLLOWING WEAR PART NUMBERS ARE FOR YOUR FUTURE REFERENCE:

KNIFE	40299.000.K3	SAFETY RELAY (3)	700-HK32Z24
PIN GRIPPER	40252.005	THIN RELAY (5)	700-24 GSK
HOOK GRIPPER	40252.008	PROX SENSOR (2)	700-PBM6-AP
SHEAR LOWER	40241.002	THICKNESS SWITCH	700-DPP01
SHEAR UPPER	40241.003	CODE LOCATED HERE ON EACH SERIAL DOC	

### Dx Industrial Slicers

1805 Industrial Park Drive  
Normal, IL 61761  
(309) 590-0300

[www.dxslicer.com](http://www.dxslicer.com)  
[support@dxslicer.com](mailto:support@dxslicer.com)